



Patent
Landscape
Report

Generative Artificial Intelligence



Patent
Landscape
Report

Generative Artificial Intelligence

This work is licensed under Creative Commons Attribution 4.0 International.

© WIPO, 2024

The user is allowed to reproduce, distribute, adapt, translate and publicly perform this publication, including for commercial purposes, without explicit permission, provided that the content is accompanied by an acknowledgement that WIPO is the source and that it is clearly indicated if changes were made to the original content.

First published 2024

World Intellectual Property Organization
34, chemin des Colombettes, P.O. Box 18
CH-1211 Geneva 20, Switzerland

Suggested citation: World Intellectual Property Organization (WIPO) (2024). Generative Artificial Intelligence. Patent Landscape Report. Geneva: WIPO. <https://doi.org/10.34667/tind.49740>

ISBN: 978-92-805-3648-5 (print)
ISBN: 978-92-805-3649-2 (online)

For any derivative work, please include the following disclaimer: "The Secretariat of WIPO assumes no liability or responsibility with regard to the transformation or translation of the original content."

ISSN: 2790-7007 (print)
ISSN: 2790-7015 (online)

Cover: Getty Images / Just_Super, Naeblys

When content published by WIPO, such as images, graphics, trademarks or logos, is attributed to a third party, the user of such content is solely responsible for clearing the rights with the right holder(s).

To view a copy of this license, please visit <https://creativecommons.org/licenses/by/4.0>

Any dispute arising under this license that cannot be settled amicably shall be referred to arbitration in accordance with Arbitration Rules of the United Nations Commission on International Trade Law (UNCITRAL) then in force. The parties shall be bound by any arbitration award rendered as a result of such arbitration as the final adjudication of such a dispute.

The designations employed and the presentation of material throughout this publication do not imply the expression of any opinion whatsoever on the part of WIPO concerning the legal status of any country, territory or area or of its authorities, or concerning the delimitation of its frontiers or boundaries.

This publication is not intended to reflect the views of the Member States or the WIPO Secretariat.

The mention of specific companies or products of manufacturers does not imply that they are endorsed or recommended by WIPO in preference to others of a similar nature that are not mentioned.

Contents

Acknowledgments	5
Key findings and insights	7
Introduction	13
Generative AI – new systems with a long history	13
Motivation of this report	16
1 Generative AI: The main concepts	19
Background and historical origins	19
Deep learning	20
Discriminative versus generative tasks	20
What GenAI models exist?	22
What are GenAI modes?	23
2 Global patenting and research in GenAI	33
Global development	33
Top patent owners	35
Key locations of inventors	40
Key filing jurisdictions	43
3 Patent trends in GenAI models	45
Global development	45
Top patent owners	46
Key locations of inventors	49
4 Patent trends in GenAI modes	51
Global development	51
Top patent owners	52
Key locations of inventors	55
Connection between GenAI models and GenAI modes	55
5 Patent trends in GenAI applications	57
Global trends	57
Top patent owners	59
Key locations of inventors	62
Connection between core models and applications	63
Connection between modes and applications	65

Further considerations	67
Concerns about the use of GenAI	67
Limitations and future of patent analysis in relation to GenAI	69
Appendices	71
A.1 Methodology for patent analysis	71
A.2 Patent indicators	73
A.3 Interdependence between models, modes and applications	74
A.4 Patent searches	77
A.5 Prompts	82
A.6 Scientific publication query with The Lens	86
A.7 Mining software and dataset mentions in the non-patent literature corpus	86
A.8 Descriptions/example patents for GenAI applications	87
References	105

Acknowledgments

This Patent Landscape Report on Generative Artificial Intelligence was prepared under the stewardship of Marco Alemán (Assistant Director General, IP and Innovation Ecosystems Sector) and under the direction of Alejandro Roca Campaña (Senior Director, IP for Innovators Department) and Andrew Czajkowski (Director, Technology and Innovation Support Division), and was led by Christopher Harrison (Patent Analytics Manager, IP Analytics Section, Technology and Innovation Support Division) with the generous financial support by Funds-In-Trust Japan Industrial Property Global provided by the Japan Patent Office.

The report was prepared by a project team led by Christopher Harrison and Lakshmi Supriya (Patent Analytics Officer, IP Analytics Section, Technology and Innovation Support Division) that included Kai Gramke, Jochen Spuck, Klaus Jank and Michael Freunek (all from EconSight), Patrice Lopez (science-miner) as well as Hong Kan (Patent Analytics Officer, IP Analytics Section, Technology and Innovation Support Division), Aleksandr Belianov and Craig Dsouza (former Young Experts, Technology and Innovation Support Division).

Our thanks also go to Ulrike Till (Director, IP and Frontier Technologies Division) for reviewing the report and providing valuable input. Finally, our gratitude to the WIPO editorial and design team led by Charlotte Beauchamp (Head, Publications and Design Section).

email: ip.analytics@wipo.int

Key findings and insights

The release of OpenAI's ChatGPT chatbot in November 2022 has greatly increased public enthusiasm for generative AI (GenAI). It has been described by many, including Nvidia CEO Jen-Hsun Huang, as an "iPhone moment" for GenAI. This is because the OpenAI platform has made it easier for all users to access advanced GenAI programs, particularly large language models (LLMs). These models have reached new levels of performance, demonstrating the potential for various real-world applications, triggering a wave of research and development, and large corporate investments in GenAI.

This WIPO Patent Landscape Report provides observations on patenting activity and scientific publications in the field of GenAI and builds on the 2019 WIPO Technology Trends publication on Artificial Intelligence. It aims to shed light on the current technology development, its changing dynamics and the applications in which GenAI technologies are expected to be used. It also identifies key research countries, companies and organizations.

GenAI patent families and scientific publications have increased significantly since 2017

The rise of GenAI over the past few years has been driven primarily by three factors: more powerful computers, the availability of large datasets as a source of training data, and improved AI/machine learning algorithms. Developments such as the transformer architecture in LLMs have significantly advanced GenAI. This has made it possible to develop complex applications in many different fields.

The technological advances in GenAI are reflected by the sharp increase in patenting activity. Over the past 10 years, the number of patent families in GenAI has grown from just only 733 in 2014 to more than 14,000 in 2023. Since the introduction of the transformer in 2017, the deep neural network architecture behind the Large Language Models that have become synonymous with GenAI, the number of GenAI patents has increased by over 800%. The number of scientific publications has increased even more over the same period, from just 116 in 2014 to more than 34,000 in 2023. Over 25% of all GenAI patents and over 45% of all GenAI scientific papers were published in 2023 alone.

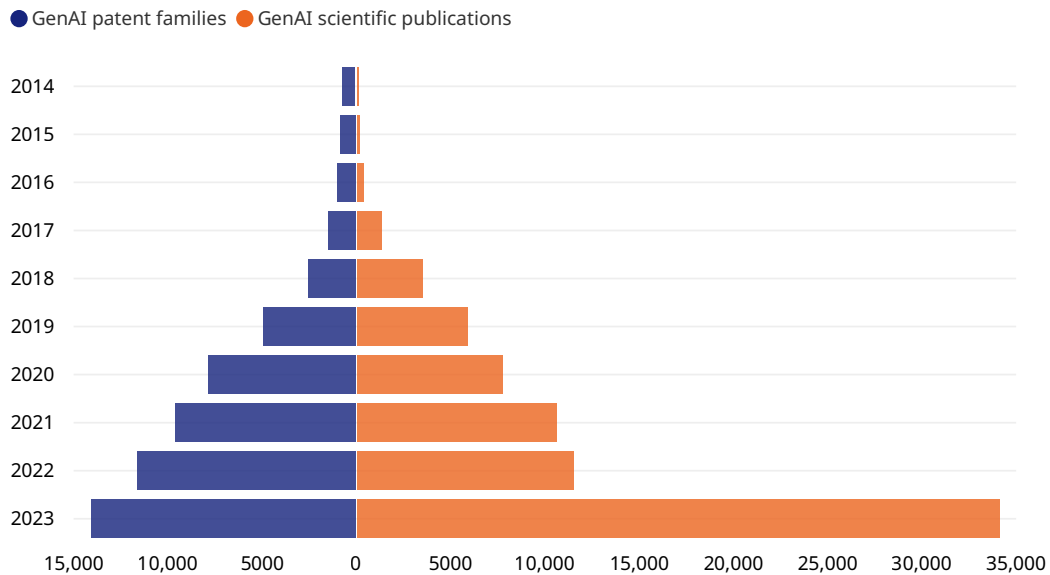

Which are the top organizations with the most patents in GenAI?

1. Tencent
2. Ping An Insurance Group
3. Baidu
4. Chinese Academy of Sciences
5. IBM

Tencent, Ping An Insurance Group and Baidu own the most GenAI patents. Tencent plans to add GenAI capabilities to its products such as WeChat to improve the user experience. Ping An focuses on GenAI models for underwriting and risk assessment. Baidu was one of the early players in GenAI and recently unveiled its latest LLM-based AI chatbot, ERNIE 4.0. The Chinese Academy of Sciences (fourth) is the only research organization in the top 10 ranking. Alibaba (sixth) and Bytedance (ninth) are other Chinese companies in the top 10.

IBM (fifth), Alphabet/Google (eighth) and Microsoft (10th) are the top US companies in terms of GenAI patents. IBM has developed a GenAI platform, watsonx, which enables companies to deploy and customize LLMs with a focus on data security and compliance. Alphabet/Google's AI division DeepMind recently released its latest LLM model, Gemini, which is gradually being integrated into Alphabet/Google's products and services. Microsoft is another key player in GenAI and an investor in OpenAI. OpenAI itself has only recently filed its first GenAI patents. Rounding out the top 10 is electronics conglomerate Samsung Electronics (seventh) from the Republic of Korea.

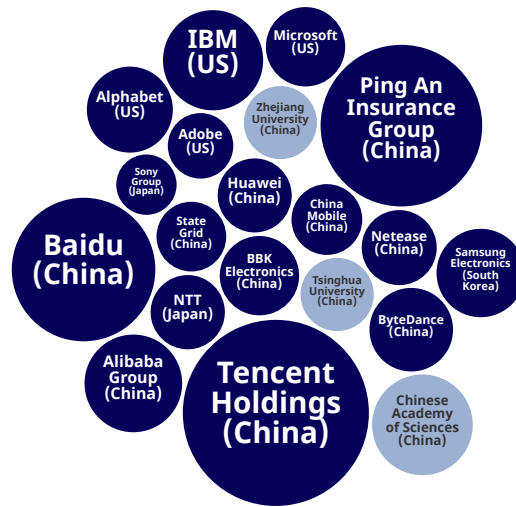

Which institutions published the most scientific publications on GenAI?

The Chinese Academy of Sciences is clearly in the lead in terms of scientific publications with more than 1,100 publications since 2010. Tsinghua University and Stanford University follow in second and third place with more than 600 publications each. Alphabet/Google (fourth) is the only company in the top 20 (556 scientific publications).

However, when measuring the impact of scientific publications by the number of citations, companies dominate. Alphabet/Google is the leading institution by a wide margin, and seven other companies are present in the top 20. The case of OpenAI is also noteworthy. In our GenAI corpus of scientific publications, the company has published only 48 articles (325th institution in terms of number of publications), but these publications have received a total of 11,816 citations from other scientific publications (13th overall).

Where are the most GenAI technologies invented?

1. China
2. United States
3. Republic of Korea
4. Japan
5. India
6. United Kingdom
7. Germany

Inventors based in China were responsible for more than 38,000 patent families between 2014 and 2023, based on the inventor addresses published on patents. Since 2017, China has published more patents in this field each year than all other countries combined.

With around 6,300 patent families between 2014 and 2023, the US is the second most important research location for GenAI patenting. The Asian countries Republic of Korea, Japan and India are other key research locations for GenAI, all ranking in the top 5 countries worldwide (third, fourth and fifth respectively). The United Kingdom is the leading European location (sixth globally), with 714 patents published in the same period. However, Germany is close behind (708 patent families) and has published more GenAI patents than the UK in recent years. These top inventor locations account for the majority (94%) of global patenting activity related to GenAI.

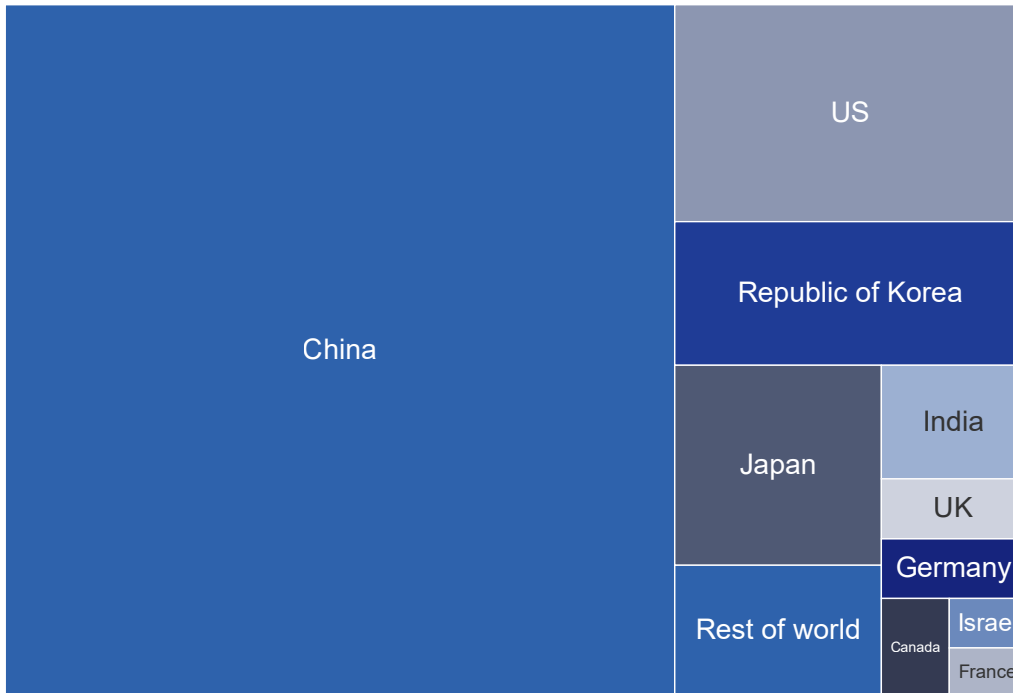

Which GenAI model has the most patents?

In recent years, a number of GenAI programs, or models, have been developed. Among the most important GenAI models are:

1. generative adversarial networks (GANs)
2. variational autoencoders (VAEs)
3. decoder-based large language models (LLMs)

However, not all GenAI patents can be assigned to these three specific core models based on available information from patent abstracts, claims or titles.

Among these GenAI models, most patents belong to GANs. Between 2014 and 2023, there were 9,700 patent families of this model type, with 2,400 patent families published in 2023 alone. VAEs and LLMs are the second and third largest models in terms of patents, with around 1,800 and 1,300 new patent families respectively between 2014 and 2023.

In terms of patent growth, GAN patents show the strongest increase over the past decade. However, this has slowed down recently. In contrast, diffusion models and LLMs show much higher growth rates over the last three years, with the number of patent families for diffusion models increasing from 18 in 2020 to 441 in 2023 and for LLMs increasing from 53 in 2020 to 881 in 2023. The GenAI boom caused by modern chatbots such as ChatGPT has clearly increased research interest in LLMs.

What are the main types of data used in GenAI patents?

The main GenAI data types include:

- Image
- Video
- Speech
- Sound
- Music

Among the different GenAI modes, or the type of data input and output, most patents belong to the image/video category. Image/video data is particularly important for GANs. Patents involving the processing of text and speech/sound/music are key data types for LLMs. The remaining modes: 3D image models, chemical molecules/genes/proteins and code/software have far fewer patents so far. As with patents related to GenAI core models, some patents cannot be clearly assigned to a specific data type. In addition, some patents are assigned to more than one mode because certain GenAI models, such as multimodal large language models (MLLMs), overcome the limitation of using only one type of data input or output.

Top application areas of GenAI patents

The key application areas for GenAI patents include:

1. Software
2. Life sciences
3. Document management and publishing
4. Business solutions
5. Industry and manufacturing
6. Transportation
7. Security
8. Telecommunications

GenAI is bound to have a significant impact on many industries as it finds its way into products, services and processes, becoming a technological enabler for content creation and productivity improvement. For example, there are many GenAI patents in life sciences (5,346 patent families between 2014 and 2023) and document management and publishing (4,976). Other notable applications with GenAI patents ranging from around 2,000 to around 5,000 over the same period are business solutions, industry and manufacturing, transportation, security and telecommunications.

In the life sciences sector, GenAI can expedite drug development by screening and designing molecules for new drug formulations and personalized medicine. In document management and publishing, GenAI can automate tasks, save time and money, and create tailored marketing materials. In business solutions, GenAI can be used for customer service chatbots, retail assistance systems, and employee knowledge retrieval. In industry and manufacturing, GenAI enables new features like product design optimization and digital twin programming. In transportation, GenAI plays a crucial role in autonomous driving and public transportation optimization.

However, many patent families (around 29,900 patent families between 2014 and 2023) cannot be assigned to a specific application based on the patent abstract, claims or title. These patents are instead included in the category software/other applications.

Introduction

Generative AI – new systems with a long history

Artificial intelligence technologies have seen a dramatic increase in public and media attention in recent years. However, AI is not a new field of research. US and UK scientists – including theoretical mathematician Alan Turing – were already working on machine learning in the 1930s and 1940s, although the term AI did not become popular until the 1950s (McCarthy *et al.* 2006).¹ The 1950s and 1960s saw a surge of interest in many AI areas including natural language processing, machine learning and robotics. Some scientists at the time predicted that a machine as intelligent as a human would exist within a generation (Minsky 1967). These predictions proved to be overly optimistic. Progress stagnated because of the limitations of computing power and algorithmic approaches available at the time. As a result, research funding dried up, which led to the first “AI winter” in the 1970s. In the following decades, periods of high AI research intensity alternated with periods of lower activity.

For a long time, AI algorithms and software were developed for specific purposes, based on clear rules of logic and parameters specified by programmers. Even now, many AI applications rely on rule-based decisions: if this, then that. For example, virtual assistants (Siri, Alexa, etc.) are essentially command-and-control systems. They only understand a limited list of questions and requests and fail to adapt to new situations. They cannot apply their “knowledge” to new problems or deal with uncertainty.

AI in the 21st century

The modern AI boom started at the beginning of the 21st century and has been on an upward trajectory ever since. Today, AI and machine learning is used in countless applications, including search engines, recommendation systems, targeted advertising, virtual assistants, autonomous vehicles, automatic language translation, facial recognition and many more. The rise of AI has been driven mainly by the following factors:

- More powerful computers: In 1965, Gordon Moore observed that the number of transistors on computer chips doubles approximately every two years and predicted that this would continue for another 10 years (Moore 1965). His law has held true for more than half a century. This exponential growth translated into more and more powerful AI systems, often with AI-specific enhancements.
- Big data: Second, the availability of data has increased similarly exponentially. This has provided a powerful source of training data for AI algorithms and has made it possible to train models with billions of images or a hundred billion tokens² of text.
- Better AI/machine learning algorithms: New methods that allow AI systems to better use data and algorithms to learn the way humans do, such as deep learning, have enabled breakthroughs in areas such as image recognition or natural language processing (WIPO 2019).

¹ The term “Artificial Intelligence” has been vastly influenced by John McCarthy at Dartmouth, who co-organized with Marvin Minsky the Dartmouth Summer Research Project on Artificial Intelligence in 1956.

² Tokens are common sequences of characters found in a set of text. Tokenization breaks text into smaller parts for easier machine analysis, helping AI models understand human language.

Learning with examples rather than rules

The heart of modern AI is machine learning, when computer systems learn without being specifically programmed to do so. Modern AI models are fed with examples of input data and the desired outcome, allowing them to build models or programs that can be applied to entirely new data. Machine learning excels at handling massive datasets and uncovering hidden patterns within them.

A powerful approach within machine learning is called deep learning. It leverages complex structures called artificial neural networks, loosely modeled after the human brain. These networks identify patterns within datasets. The more data they have access to, the better they learn and perform. Information flows through numerous layers of interconnected neurons, where it is processed and evaluated. Each layer refines the information, connecting and weighting it through nodes. Essentially, AI learns by continuously reassessing its knowledge, forming new connections and prioritizing information based on new data it encounters. The term deep learning refers to the vast number of layers these networks can utilize. Deep learning-powered AI has achieved remarkable advancements, especially in areas like image and speech recognition. However, its success comes with a drawback. While the accuracy of the results is impressive, the decision-making process remains unclear, even to AI experts. This lack of transparency is a contrast to older rule-based systems.

Modern generative AI (GenAI): the next level of AI

Generative AI (GenAI) has been an active area of research for a long time. Joseph Weizenbaum developed the very first chatbot, ELIZA, in the 1960s (Weizenbaum 1966). However, GenAI as we know it today was heralded by the advent of deep learning based on neural networks.

Today, GenAI is one of the most powerful examples of machine learning. Compared to old rule-based AI applications that could only perform a single task, modern GenAI models are trained on data from many different areas, without any limitations in terms of task. Because the amount of training data is so large – OpenAI's GPT-3 was trained on more than 45 terabytes of compressed text data (Brown *et al.* 2020) – the models appear to be creative in producing outputs. For example, traditional chatbots follow scripted responses and rely on pre-defined rules to interact with users, making them suitable only for specific tasks. In contrast, modern GenAI chatbots such as ChatGPT or Google Gemini can generate human-like text, allowing for conversations that can adapt to many topics without being confined to a predetermined script. In addition, these modern chatbots can produce not only text, but also images, music and computer code based on the dataset on which they were trained.

The release of ChatGPT in 2022 was an iPhone moment for GenAI

In November 2022, OpenAI released ChatGPT (Chat Generative Pre-trained Transformer) to the public, which greatly increased public enthusiasm for GenAI. More than one million people signed up to use ChatGPT in just five days. A 2023 survey by auditing and consulting firm Deloitte found that nearly 61% of respondents in Switzerland who work with a computer already use ChatGPT or other GenAI programs in their daily work (Deloitte 2023). The ChatGPT release has been described by many, including Nvidia CEO Jen-Hsun Huang, as an "iPhone moment" for GenAI (VentureBeat 2023). This is partly because the platform made it easier for users to access advanced GenAI models, specifically decoder-based large language models.³ These models have demonstrated the potential for many real-world applications and have sparked a wave of research and development. Many companies are heavily investing in GenAI, with these newer models reaching a new dimension of capabilities.

3 See next chapter for an overview and description of the different modern GenAI models.

A brief timeline of GenAI

1957	• Frank Rosenblatt introduces the perceptron, the fundamental building block of neural networks (Rosenblatt 1957)
1972	• Amari-Hopfield Networks make recurrent neural networks able to learn, as a form of associative memory (Amari 1972, Hopfield 1982)
1997	• Long Short Term Memory (LSTM) recurrent neural networks are published, which will become one of the most successful deep learning architectures in the 2010s (Hochreiter and Schmidhuber 1997)
1990	• Markov networks and other statistical language models led to effective AI commercial systems, such as the first versions of Google Translate
2013	• Variational Autoencoders (VAEs), an Auto-encoder approach able to generate new realistic image samples from input images (Kingma and Welling 2013)
2014	• Generative Adversarial Networks are described, which will lead to various generative applications around photorealistic images
2016	• WaveNet by DeepMind, a novel deep neural network approach for realistic human speech (van den Oord et al. 2016)
2017	• A team from Google Research introduces the transformer, the deep neural network architecture behind the Large Language Models (Vaswani et al. 2017).
2018	• GPT, the first generative language model of OpenAI, a transformer of 120 million parameters (OpenAI 2018)
2019	• GPT-2, a transformer model of 1.5 billion parameters, impress the research community with its ability to generate coherent texts (OpenAI 2019)
2020	• March - NeRF, a deep learning method for generating 3D scenes (Mildenhall et al. 2020)
2020	• December - GPT-3 (Brown et al. 2020), the new iteration of OpenAI LLM reaches 175 billion parameters
2021	• January - DALL-E, developed by OpenAI, generates realistic art images from natural language text prompts (OpenAI 2021)
2021	• June - GitHub Copilot, a GPT-3 variant trained at scale on programming code (GitHub 2021)
2021	• July - AlphaFold 2, from DeepMind, wins the CASP14 competition on predicting protein structures, with accuracy comparable to costly manual experimental techniques (Jumper et al. 2021)
2022	• April - Stable Diffusion (Rombach et al. 2021) and MidJourney (Midjourney 2022) democratize GenAI in popular culture
2022	• November - ChatGPT makes LLM accessible to everybody and becomes the fastest product to attain 100 million users (OpenAI 2022)
2023	• January - MusicML generates songs from prompts (Agostinelli et al. 2023)
2023	• February - Google unveils its experimental conversational AI service, Bard
2023	• March - GPT-4.0 can handle images and significantly more text than its predecessor (OpenAI 2023)
2023	• July - Meta release Llama 2, an open-source large language model, available at no cost for research and commercial use
2023	• December - Axel Springer comes to an agreement with OpenAI, The New York Times sues OpenAI and Microsoft for copyright infringement
2024	• February - OpenAI presents Sora, an LLM that can generate videos up to a minute long with high visual quality from user prompts (Brooks et al. 2024)
2024	• April - Meta introduces Llama 3, pretrained on over 15 trillion tokens, 50 times more than GPT-3 and 7 times more than Llama 2
2024	• May - Open AI releases GPT-4o, which can accept and generate multimodal (text, audio, image, video) outputs

Source: WIPO

Motivation of this report

This WIPO Patent Landscape Report provides observations on patenting activity and scientific publications in the field of GenAI. The analysis builds on the 2019 WIPO Technology Trends publication on Artificial Intelligence (WIPO 2019).

GenAI is expected to play an increasingly important role in various real-world applications and industries. It is therefore important to understand the technological trends in the field of GenAI in order to adapt business and intellectual property (IP) strategies. The aim of this report is to shed light on the current technology development, its changing dynamics and the applications in which GenAI technologies are expected to be used. It also identifies key research locations, companies and organizations.

As GenAI can be used for many different applications, we use a multi-angle perspective to gain an in-depth understanding. In particular, the analysis is based on three different perspectives illustrated by Figure 1.

The analysis was done using three perspectives: the computer programs used, or models; the type of input and output, or modes; and the applications of Gen AI.

Figure 1 Concept of the analysis

Models	Modes	Applications	
Generative Adversarial Networks (GANs)	Image, Video	Software and other applications	Physical Sciences/Engineering
Large-Language-Models (LLMs)	Other Modes	Life Sciences	Entertainment
Variational Autoencoder	Text	Document management/Publishing	Computing in Government
Autoregressive Models	Speech, Voice, Music	Business Solutions	Arts and Humanities
Diffusion Models	3D Image Modelling	Industry/Manufacturing	Networks/Smart City
Other GenAI Models	Molecule, Genes, Proteins	Transportation	Energy Management
	Code	Security	Cartography
		Telecommunications	Industrial property, law, social behavioural sciences
		Personal Devices	Agriculture
		Banking/Finance	Military
		Education	

Source: WIPO, EconSight.

- The first perspective covers the GenAI models. Patent filings related to GenAI are analyzed and assigned to different types of GenAI models (autoregressive models, diffusion models, generative adversarial networks (GAN), large language models (LLMs), variational autoencoders (VAE) and other GenAI models).
- The second perspective shows the different modes of GenAI. The term “mode” describes the type or mode of input used and the type of output produced by these GenAI models. Based on keywords in the patent titles and abstracts, all patents are assigned to the corresponding modes: image/video, text, speech/voice/music, 3D image models, molecules/genes/proteins, software/code and other modes.

- The third perspective analyzes the different applications for modern GenAI technologies. The real-world applications are numerous, ranging from agriculture to life sciences to transportation and many more.

1 Generative AI: The main concepts

This chapter provides a summary of the main technical principles around GenAI, including its origins and some historical background. Deep neural networks can usually be adapted to be either discriminative or generative tasks, which has led to the development of various types of GenAI models, which can support different types of input and output data (modes).

Background and historical origins

This chapter provides a summary of the main technical principles around GenAI, including some historical background. GenAI is currently defined more in a descriptive manner than by precise technical features. The Organisation for Economic Co-operation and Development (OECD) defines GenAI as "a technology that can create content, including text, images, audio, or video, when prompted by a user" (Lorenz *et al.* 2023). "Prompts" here correspond to textual instructions, usually produced by the human users, optionally combined with some given data. Although not mentioned, it is expected that the generated content is new, meaningful and human-like.

In the recent AI Act, the European Union defines GenAI as a type of foundation model (European Commission, European Parliament 2023). Foundation models correspond to general purpose AI models trained on large and diverse datasets in order to be used more easily for many different tasks. GenAI systems are a specific subset of foundation models "specifically intended to generate, with varying levels of autonomy, content such as complex text, images, audio or video." This definition emphasizes that new content is generated based on existing large training datasets, raising various issues and biases more particularly addressed by the AI Act.

From the point of view of general users, one key aspect is that unlike the traditional "supervised" machine learning models, which require a large amount of task-specific annotated training data, these models can generate new content just by writing natural language prompts. Therefore, using GenAI tools based on these models does not require technical skills. For the first time, modern cutting-edge AI becomes directly accessible to the general public.

This accessibility has made possible a widespread diffusion of GenAI tools in the last two years. For example, in 2022, models like Stable Diffusion (Rombach *et al.* 2021) and Midjourney (Midjourney 2022) have attracted a lot of attention on social media and democratized GenAI in popular culture (Midjourney 2022). ChatGPT for conversational systems became the fastest product to attain 100 million users (OpenAI 2022). On the professional side, GitHub Copilot (GitHub 2021) has anchored GenAI in software development: 92% of US-based developers are already using AI coding tools according to a recent GitHub survey (GitHub 2023b).

The developments that led to GenAI have been a long and steady progress in the field of machine learning and neural networks. Amari-Hopfield Network (Amari 1972, Hopfield 1982), a type of neural network with associative memory, and Long Short Term Memory (LSTM) recurrent neural networks (Hochreiter and Schmidhuber 1997), are often mentioned as early foundations for the development of GenAI. The Amari-Hopfield Network demonstrated how networks could store and retrieve patterns, resembling human memory processes. LSTM

recurrent neural networks expanded on this by introducing a mechanism to capture and learn complex sequential patterns, overcoming the limitations of traditional recurrent networks in handling long-range dependencies.

Early effective GenAI was however not based on neural networks, but on probabilistic graphical models such as Markov networks, which learn transitions over states in graph-based representations rather than using bio-inspired structures. These statistical language models had already led to practical commercial applications in the 1990s.

Language models aim at predicting a next "token," for example a word, given a sequence of observed tokens. Applied iteratively, it is possible to generate text or speech that mimics human language. This iterative method for generating sequences, like a sequence of words, is characteristic of so-called autoregressive models and can be viewed as an auto-completion function. Successful early applications include machine translation, such as Google statistical machine translations deployed in the 2000s, as well as speech and text generation.

Deep learning

In the 2010s, neural networks became the dominant approach in AI with deep learning. Although neural networks are well known since the 1950s (Rosenblatt 1957), these models could only use a very limited number of neurons and layers – such as the so-called multilayer perceptron (MLP) – until the 1990s. Deep learning is the result of 30 years of cumulative progress to increase ("deepen") the number of layers of neural networks.

With traditional machine learning techniques, the performance can quickly reach a plateau as the amount of training data increases. Adding more data thus becomes useless after a while. One of the key properties of deep learning is that the performance continuously increases with the increase in training data. In other words, the more data we feed to a deep neural network (DNN), the better the deep neural network generally performs. The performance of these models becomes conditioned by the capacity of the computers and the amount of data used for training. Deep learning can surpass any other machine learning approaches, as long as massive data and computing resources are available.

One of the main findings of the WIPO Technology Trends on Artificial Intelligence was that deep learning was by far the biggest and fastest growing technique in AI at the end of the 2010s, both for patents and non-patent literature (WIPO 2019). The progress in deep learning led to breakthrough results in so-called generative tasks.

Discriminative versus generative tasks

Deep neural networks can usually be adapted to two different kinds of tasks:

- *Discriminative* tasks involve a decision on the input data, such as classification, identifying names in texts or segmenting an image. *Discriminative* models are models adapted and trained to separate input data into these different classes.
- *Generative* tasks involve the creation of new data samples given some input data. *Generative* models are models adapted and trained to create such new data. They are typically used to translate text, generate images, summarize text or answer questions.

Figures 2 and 3 illustrate these fundamental types of machine learning tasks. Discriminative models excel in classification but cannot generate new data. In contrast, generative models can also address discriminative tasks, but with lower accuracy than discriminative models. Generative models have more parameters, are computationally more expensive and often require more training data than discriminative models.

The model must learn how to distinguish two classes: the painting *Mona Lisa* and other paintings. For this sort of model, the learning process focuses on the criteria to distinguish the classes. So, expressed as a space of painting characteristics, the model concentrates on representing the boundary between the two classes of paintings.

Figure 2 A discriminative task for classifying if an image is the *Mona Lisa* painting or not

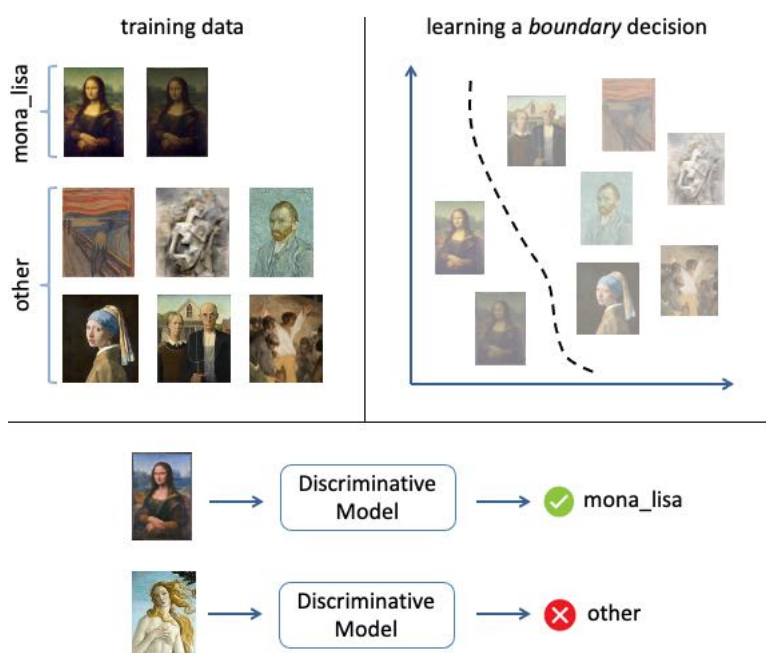

Source: WIPO, painting visuals from Wikimedia Commons under public domain.

For the generative task, the model must learn the global aspect of every painting to be able to generate coherent new paintings. For this sort of model, the learning focuses on representing the global distribution of the characteristics of the painting. The two generated images were produced using the original Stable Diffusion model.

Figure 3 A generative task for producing new painting samples

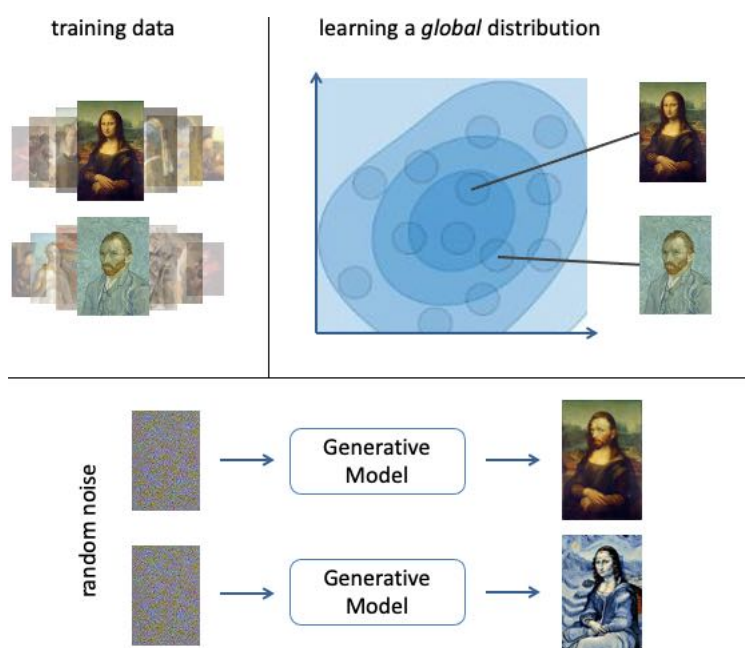

Source: WIPO, Painting visuals from Wikimedia Commons under public domain.

What GenAI models exist?

With its ability to represent and learn complex data patterns and to scale them, deep learning appeared very well-fitted for data generation, but also for modeling different types of data. In recent years, it has enabled the development of various types of GenAI models. Among the most significant are generative adversarial networks (GANs), decoder-based large language models (LLMs), variational autoencoders (VAE), and diffusion models.

Generative adversarial network

A generative adversarial network (GAN) is a deep learning model for task generation introduced in 2014 by Goodfellow *et al.* (2014). A GAN consists of two parts, a *generator* and a *discriminator*. The *generator* is a neural network generating output images and the *discriminator* a neural network evaluating how realistic the image generated by the *generator* is. The generation process is then a competition between these two parts. The generator tries to improve its output to mislead the discriminator and the discriminator tries to improve its ability to distinguish real images from generated ones, to avoid being misled by the generator. As a result, the generator will maximize its capacity to generate realistic images. GANs are used today for many tasks involving images such as generation and enhancement of photorealistic images.

Large Language Models

Large Language Models (LLMs) are the basis of modern conversational systems (chatbots) such as ChatGPT or Bard. These models are trained on large datasets to learn the patterns and structures within the data, enabling them to generate new content that is coherent and contextually relevant. LLMs in GenAI focus specifically on generating human-like text by predicting the next statistically most likely word and are used for various natural language processing tasks, including text completion, language translation, summarization and more. The training process of LLMs involves pre-training on a large corpus of text data, allowing the model to learn the statistical properties and linguistic nuances of the language. To achieve this, most of the LLMs use transformers, a type of neural network architecture designed specifically for natural language processing (NLP) tasks, that were introduced first in 2017 (Vaswani *et al.* 2017). Transformers have allowed researchers to train increasingly large models without having to label all the data beforehand. They are based on the idea of self-attention, which means they can focus on different parts of the text simultaneously. This allows them to capture long-range dependencies in text, which is important for understanding and phrasing complex language. As a result, LLM-based chatbots are able to generate text that is coherent and contextually relevant.

Once trained, the models can be fine-tuned for specific tasks or used directly to generate diverse and contextually appropriate text. Recently, multimodal large language models (MLLMs) have been gradually taking the lead from traditional LLMs. MLLMs are overcoming the limitation of purely text-based input and can access knowledge from multiple modalities – and can thus interact more fully with the real world.

(Variational) Auto-encoder

An auto-encoder model is based on three parts: encoder, code and decoder. The encoder is a neural network that learns how to encode and compress input data into an intermediary representation, the code, which is basically a sequence of numbers. The code is then used by the decoder, another neural network, which has learnt how to decompress and reconstruct data into the expected input format. Beyond data compression, the objective of the autoencoders is to learn how to represent the nature of some data, so that a small modification of this internal representation can still be re-constructed into a new meaningful output. Autoencoders are common in GenAI today. A large number of variants have introduced multiple improvements, such as the popular variational autoencoders (VAEs), published in 2013 (Kingma and Welling 2013), and used for generating sophisticated and diverse image samples.

The original transformer model (Vaswani *et al.* 2017) is also an encoder-decoder architecture. It has been adapted for creating large language models used for text generation by keeping only

the decoder part in the case of the OpenAI GPT model family. In other terms, modern LLMs are *decoder-based* large language models.

Autoregressive models

Autoregressive models are a class of probabilistic models that describe the probability distribution of a sequence of observations by modeling the conditional probability of each observation given the previous observations in the sequence. In other words, autoregressive models predict the next value in a sequence by considering the previous values.

In the context of GenAI, autoregressive models are often used to generate new data samples.

A model is trained on a dataset, which is then used to generate new data points by predicting one element at a time, based on the previously generated elements. This makes autoregressive models suitable for tasks such as language generation, image synthesis and other generative tasks. Examples of autoregressive models in GenAI include autoregressive moving average (ARMA) models, autoregressive integrated moving average (ARIMA) models and PixelCNN for image generation. Autoregressive models have been particularly successful when applied to natural language processing tasks (e.g. most modern LLMs, such as GPT-3 or GPT-4 are autoregressive) and image generation tasks, such as PixelCNN.

Diffusion model

Diffusion models are inspired from the concept of *diffusion*, which is used in physics to model the movement of a set of particles in two different physical areas. A diffusion model for image generation involves a neural network to predict and remove noise in a given noisy image. The generation process is equivalent to first applying random noise (random pixels) to an image and then iteratively using the neural network to remove the noise. As the noise is progressively removed, a novel and meaningful image is constructed, controlled by additional machine learning mechanisms, as illustrated by Figure 4. Diffusion models have made considerable progress in recent years and are now very successful for text-to-image generations, such as the Stable Diffusion (Rombach *et al.* 2021) and the DALL-E model families (OpenAI 2021).

With the prompt “a cat reading a patent” an image is generated, from random pixels to the final image, using the original Stable Diffusion model.

Figure 4 Stable Diffusion denoising process



Source: WIPO

What are GenAI modes?

Generative AI models are very effective for a variety of applications, to a point where they can challenge some aspects of human creativity. Mature models support different types of input and output data (modes) and are not limited to text and images, making GenAI relevant potentially to many economic areas.



Image, video

One data type for GenAI is images and videos. Generative models can typically translate an image to another image, enhancing or modifying the style of the input image. To learn the patterns and relationships between pixels, GenAI models are trained on large datasets of images and videos, but also combined with text. For example, diffusion models can produce impressive high-resolution images from short textual description, as illustrated by Stable

Diffusion, released in 2022 (Rombach *et al.* 2021). In another way, models such as OpenAI's CLIP (Contrastive Language-Image Pre-training) in 2021 (Radford *et al.* 2021) or the larger DeepMind's Flamingo in 2022 (Alayrac *et al.* 2022) are used to generate, for instance, captions from an image or from videos. Figure 5 further illustrates Flamingo's ability to analyze an image following a text prompt in the form of a question.

By analyzing an image, the Flamingo model can generate text, as shown here, providing an answer based on the image to a question.

Figure 5 Illustration of DeepMind's Flamingo model combined image analysis and text generative abilities

Input Prompt	 <p>Question: What do you think the capacities of these are? Answer:</p>	 <p>Question: What is odd about this image? Explain why it is unusual. Answer:</p>	 <p>Question: What country is this? Why do you think so? Answer:</p>
Completion	<p>The floppy disk is 1.44MB and the CD is 700MB.</p>	<p>The image is odd because the elephant is in the back of the truck. It is unusual because elephants are not usually transported in the back of a truck.</p>	<p>It is Canada. I think so because the flag is the Canadian flag.</p>

Source: WIPO, based on an excerpt from (Alayrac *et al.* 2022). All visuals licensed under CC BY-ND 2.0.

Text

The releases of the GPT (Generative Pre-Trained) model by OpenAI in 2018 (OpenAI 2018) and more significantly of GPT-2 in 2019 (OpenAI 2019) have accelerated the development of GenAI. These LLMs rely on text as the main data mode. The core technique of the current text-based approaches is to use the deep learning architecture called transformer (Vaswani *et al.* 2017), mentioned previously, which has the ability to maintain learning capacities from a large amount of unlabeled text, scaling to billions of parameters as the number of layers in the model increases. This sort of model can address a large variety of tasks, such as automatic summarization, machine translation, essay generation, paraphrasing or writing style enhancement, in a reliable manner.

In November 2022, ChatGPT demonstrated the new capacity of LLM-based chatbots to the broad public (OpenAI 2022). Text-based LLMs learn from extremely large amounts of texts, in the range of several hundred billions of tokens. As they maintain learning capacity, they not only learn the general language, but also how to generate text about a variety of facts concerning entities and events in the world. ChatGPT exploits this property by further training an LLM with successive prompts and replies validated by human trainers. The LLM is thus further trained (fine-tuned) for a conversational use, enabling fluent and versatile dialogs on top of the existing capacity to generate human language texts. Users can initiate any sort of conversation with the system, which responds in a human-like manner, including follow-up queries and reformulations, and factual information, in a much more convincing manner than the usual chatbots.

Since then a large number of competing products have appeared, including techniques to better control the reliability of the communicated information and to refine the dialogs. In particular, retrieval augmented generation (RAG) is a technique widely used, which restricts the provided information with the results of preliminary requests to one or several search engines. More costly, additional fine-tuning is another way of modifying the LLM itself for further specializing or improving the choice of replies.

Speech, sound, music

In 2016, DeepMind introduced WaveNet, a deep neural network able to generate audio waveforms (van den Oord *et al.* 2016). WaveNet was a milestone in generative models for realistic human speech, but more generally for any kind of audio. Previous text-to-speech systems were mostly based on concatenating relatively large sound fragments, like phonemes, together to form words and sentences. This approach requires a very high number of voice recordings from the same speaker, with often unnatural tone and cadence. WaveNet, on the contrary, learns how waveforms change over time at a very low level, recreating the sound of speech one sample at the time, with 16,000 samples generated per second. In addition to more natural sounding voices, only a few minutes of real-life recordings are required to mimic one particular voice. The same generative approach can be used for other forms of audio, like music. Trained on 280,000 hours of music by Google researchers, MusicML is a recent example of such a generative system producing entire songs from text prompts (Agostinelli *et al.* 2023).

Code

In 2021, GitHub, the main open-source software platform, and OpenAI released a programming assistant for developers called Copilot (GitHub 2021), based on a modified version of GPT-3. The LLM is trained on English language and on a massive amount of public software code repositories that the GitHub company hosts.

The assistant can perform code generation based on some natural language describing a programming problem. It can provide code completion, for example as real-time suggestions in integrated development environments. It has also the ability to comment and explain existing or generated code. Such a tool illustrates that GenAI has the potential to change the working methods of many professions, with the prospect of productivity gains.

Molecules, genes, proteins

Some GenAI models are trained on large datasets of chemical molecules, genes and proteins. This enables them to generate new chemical molecules, genes and proteins structures with desired properties. GenAI models can also be used to design new drugs and therapies, and to improve the efficiency of chemical and biological processes. In 2021, DeepMind's AlphaFold 2 system won the CASP14 competition on predicting protein structures based on a transformer model (Jumper *et al.* 2021). Knowing the stable 3D structure of a protein is necessary to understand its biological function. The "protein folding problem" is however very challenging. We only know the structures of about 170,000 proteins based on decades of experiments, out of an estimated over 200 million existing proteins across all life forms. At the CASP competition, the accuracy of AlphaFold 2 was comparable to existing experimental techniques. Generating automatically reliable protein structures is a key scientific milestone, and this result has promising implications for drug discovery.

3D image models

Less-known applications of GenAI relate to the ability to reconstruct a 3D scene from incomplete input, for example a few 2D images. Introduced in 2020, Neural Radiance Field (NeRF) is a fast deep learning method, enabling the geometric modeling of a scene, as well as a photorealistic rendering of novel views (Mildenhall *et al.* 2020). This GenAI technique has already reached the general public. Progressively deployed for certain cities in 2023, Google Immersive View uses NeRF to transform 2D street pictures into 3D representations (Tong 2023), see Figure 6. Applied to medical imaging, it allows, for example, the generation of 3D computerized tomography (CT) scans from a few or a single-view X-ray, reducing the exposure to ionizing radiation. In robotics, these techniques can help robots interact with their environment, with improved perception of transparent and reflexive objects (Corona-Figueroa *et al.* 2022). Other applications include surface reconstruction from satellite imagery or photorealistic content creation in product design or augmented reality.

Based on Neural Radiance Field (NeRF), a 3D model is generated from a set of 2D pictures. The dynamic rendering of new views is then possible, using for example different illumination conditions combined with additional layers of information.

Figure 6 Screen captures of Google Immersive View for different city landmarks, as released in June 2023 in Google Maps

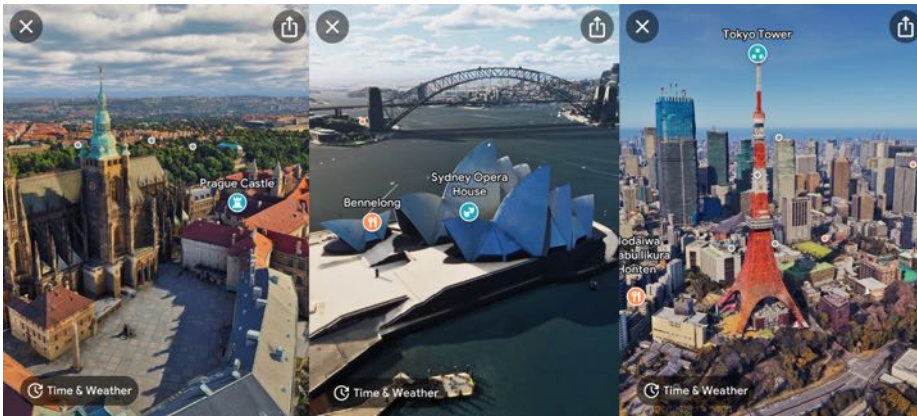

Source: Google Immersive View.

Synthetic data is becoming increasingly important

Synthetic data is annotated information that computer simulations or algorithms generate as an alternative to real-world data. It usually seeks to reproduce the characteristics and properties of existing data or to produce data based on existing knowledge (Deng 2023). It can take the form of all different types of real-world data. For example, synthetic data can be used to generate realistic images of objects or scenes to train autonomous vehicles. This helps for tasks like object detection and image classification. Because of synthetic data, millions of diverse scenarios can be created and tested quickly, overcoming limitations of physical testing.

In general, synthetic data is very useful for training AI models when data do not exist, or are incomplete or not accurate enough. The development of synthetic data is possible through a process called label-efficient learning. Labeling data is an important step in training many AI models. Traditionally, labeling data involved humans who annotate data with the desired information, which is a time-consuming and expensive process, especially for large datasets. GenAI models can reduce the cost of labeling, either by creating realistic synthetic data (images, text, etc.) with desired labels, by augmenting existing training data by generating additional labeled data points, or by learning an internal representation of the data that makes it easier to train AI models with less labeled data.

The research company Gartner expects synthetic data to become the dominant data type in GenAI by 2030 given its many advantages (Ramos and Subramanyam 2021), see Figure 7. Synthetic data allows for a rapid development of GenAI models by avoiding lengthy procedures for data acquisition.

Although the focus today is on available real data, in future artificially generated likely will become dominant.

Figure 7 Synthetic data might become increasingly important for GenAI

Synthetic data

- Artificially generated data
- Generated from simple rules, statistical modeling, simulation and other techniques

Real data

- Obtained from direct measurements
- Constrained by cost, logistics, privacy reasons

Source: WIPO, adapted from Gartner (Ramos and Subramanyam 2021).

Datasets for GenAI

The increasing availability of data has been a major factor in the development of GenAI. Many datasets have been developed and assembled for GenAI purposes. However, it is complicated to track the activity related to data, because of the high fragmentation of platforms and services related to public datasets. As of November 2023, Re3data, a worldwide registry of research data repositories, reports 3,160 different research dataset repositories in the world (Re3data 2023). Most of the data available via these platforms are distributed in open access, often under Creative Commons licenses, and come from various public institutions: research institutions, public administrations, museums, archives, etc. In addition, raw data such as large-scale web page scraping (the copy and harvesting of public web pages as rendered on web browsers) are commonly used.

The actual training data used by GenAI models is currently poorly documented. We rely on a text mining analysis of the open access subset of the GenAI corpus (34,183 articles out of a total of 75,870) to capture the actual used datasets. With this approach, we obtained a total of 978,297 dataset mentions (see Appendix A.1 for the methodology).

The top datasets are all based on images with a few text-based datasets such as Wikipedia and PubMed.

Table 1 Top 20 datasets mentioned in the open access subset of the GenAI corpus

	Dataset name	Citing documents	Total mentions	Main modality
1	ImageNet	2,741	6,823	image
2	MNIST	2,533	9,292	image
3	CIFAR-10	2,160	7,744	image
4	CelebA	1,705	5,713	image
5	COCO	1,141	3,390	image
6	Wikipedia	662	2,599	text
7	FFHQ dataset	596	1,983	image
8	FASHIONMNIST	520	1,375	image
9	CelebAHQ	474	1,081	image
10	SVHN	398	1,414	image
11	PubMed	393	1,144	text
12	GSM8K	350	1,704	text
13	CIFAR-100	338	849	image
14	HumanEval	322	1,269	text
15	LAION	314	731	image
16	CUB dataset	312	1,118	image
17	LSUN	310	608	image
18	CommonCrawl	290	546	text
19	Cityscapes	272	974	image
20	MMLU	270	746	text

Source: WIPO.

Table 1 shows that the most cited datasets appear to be image understanding datasets, such as ImageNet, MNIST, CIFAR, etc. They are commonly used in training and evaluating GenAI models, particularly GAN models. The first text-based datasets are Wikipedia and PubMed. HumanEval is the first dataset specific to text and LLM: It is an evaluation benchmark for code generation systems like GitHub Copilot (GitHub 2021).

The two main data sources to train GenAI models from scratch are LAION (position 15) and Common Crawl (position 18). Common Crawl is a non-profit organization that crawls the web

and provides its datasets freely to the public (Common Crawl 2023). Their datasets include copyrighted works that are distributed from the US under fair use claims, in the form of samples of websites. Most LLMs use Common Crawl data for training.

LAION, Large-scale Artificial Intelligence Open Network, is a non-profit organization providing large datasets related to images (image-text pairs) (LAION 2023). These datasets are behind most GenAI text-to-image models like Stable Diffusion. To mitigate copyright and GDPR issues, the datasets do not include images, but URLs (web addresses) referencing the images.

Proprietary versus open models

GenAI is bound to have a significant impact on many industries as a technological enabler for content creation and productivity improvement. To enable the practical usage of GenAI, two types of models are emerging, proprietary models and freely available open models:

- The first category includes OpenAI's GPT3 and 4 or Alphabet/Google's BARD chatbots. The companies behind these models allow developers and individuals to access their API for a fee. These models come with professional support, documentation, and large computing infrastructure, ensuring a high level of reliability and performance.
- Open models, usually called open data or open-source models, are made available to the public for free, and anyone can use, modify and distribute them, possibly with some restrictions (e.g. for commercial applications). Open models benefit from a community of developers, researchers and users as well as from transparency, since the code for running the model is usually available for scrutiny. Examples of open model are Meta's LLaMA 2 and 3 and Mistral AI series of models. However, today only a small number of models such as GPT-NeoX (EleutherAI) and OLMo (Allen Institute for AI) can be considered as fully open, releasing both model and training data, and the code for training and running the model, without usage restriction.

Availability of open access GenAI models

The Hugging Face commercial platform is currently the most popular and well-known service for sharing open access machine learning models publicly (Hugging Face 2023), without limitation to data and model types. At the time of this report, there is no comparable alternative in terms of number and versatility of shared models.

The predominant models on Hugging Face are text-based with image-only input and generation models being still a very small fraction.

Figure 8 Distribution of GenAI models by type of generated data on Hugging Face

Text (78%) Multimodal (15%) Audio (6%)
Image (1%)

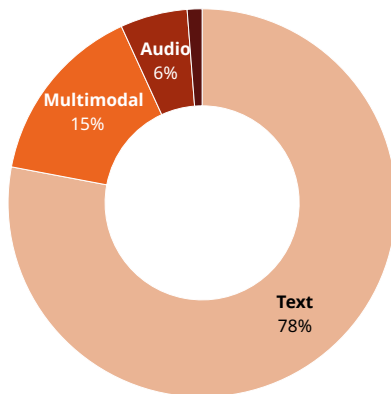

Note: Multimodal means that the input data type is different from the generated one. Source: WIPO, based on data from Hugging Face, January 2024.

Source: WIPO, based on data from Hugging Face, January 2024.

As of January 20, 2024, Hugging Face hosts 477,329 machine learning models of which 106,430 (22.3%) can be considered as GenAI models. It is possible to break down the different models in terms of the type of input and generated data (see also the following chapter for more information about data types). Figure 8 shows that text generative models are largely dominant, likely related to the rise of conversational systems in the last two years. Most of the image-based models appear multimodal, using textual prompts as input or generating image captions, rather than performing image-to-image generation.

GenAI software

The production of software is hard to track because of the multiplication of software publication channels, the variety of development environments, the distributed nature of modern software engineering and the absence of a central metadata index. However, the main open-source development platform GitHub offers a good proxy for capturing a large spectrum of activity in a single place. With a reported number of 284 million public repositories, it is the reference for open-source collaborative development (GitHub 2023c). When core technical innovations are made available very early as open-source software and open access models, large organizations can benefit from this with limited risks and investment compared to direct internal research.¹ Even without software IP, the organizations with the largest datasets and computing power can then leverage these advantages to develop leading AI systems.

Using search terms similar to the ones described in the Appendix and the GitHub public API (GitHub 2023a), we present the recent public code repository creations by months with metadata related to GenAI terms in Figure 9. We observe a boom of creations at the time of the release of ChatGPT at the end of 2022, showing a massive recent interest in open-source developments in this area. The number of repository creations then goes down, as the activity might evolve naturally to improving and supporting these created repositories. These numbers show that we are still in the middle of a very recent wave of R&D interest in GenAI.

The release of ChatGPT in late 2022 led to a boom in the creation of public code repositories.

Figure 9 GitHub repositories related to GenAI by month (without forks), 2022–2023

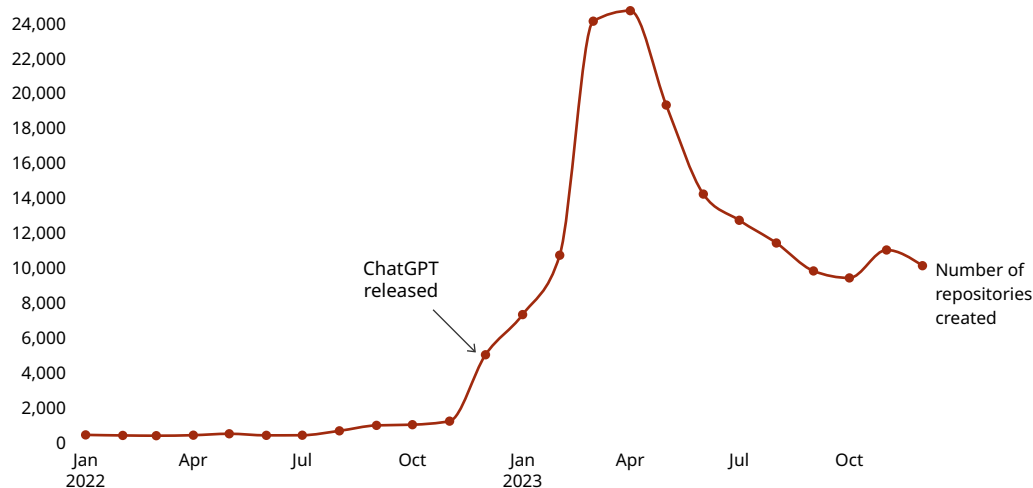

Source: WIPO, based on data from GitHub, January 2024.

Most impactful software in generative AI

Table 2 presents the top Machine Learning GitHub repositories in terms of total number of forks ever produced (figures from December 6, 2023). A fork in open-source development is a copy of an existing repository for further extending or studying it. It can be viewed as a direct measure of interest and impact. Although all are relevant for GenAI, three out of eight are specific to GenAI (ChatGPT-Next-Web, AutoGPT and stable-diffusion-webui).

¹ However, the generated code may not always be able to attribute the input code, implying wider IP issues.

Eight repositories are related to machine learning, with three specific to GenAI (highlighted in orange).

Table 2 GitHub repositories related to machine learning present in the top 100 repositories ranked by number of forks

Ranking for machine learning by number of forks	Global GitHub ranking by number of forks	Project name	Number of forks	Number of stars	Publisher
1	5	tensorflow	89,193	179,236	Google
2	15	opencv	55,760	72,799	community
3	21	ChatGPT-Next-Web	46,879	52,750	community
4	22	models	46,226	76,275	community
5	33	AutoGPT	37,701	154,414	community
6	76	scikit-learn	24,935	56,610	community
7	88	transformers	23,246	116,502	Hugging Face
8	93	stable-diffusion-webui	22,463	112,329	community

Source: WIPO, based on data from GitHub, January 2024.

However, restricting our impact study to open-source software only would be incomplete. The software mentioned in scientific publications offer a more comprehensive picture of the actual impactful software in GenAI. We conducted a text mining analysis of the open access subset (34,183 PDF articles) of our GenAI corpus of scientific publications (a set of 75,870 scientific articles) and extracted 789,218 software mentions. The methodology is presented in Appendix A.1. Table 3 presents the 20 most cited GenAI software. OpenAI's ChatGPT is the most cited software in terms of citing documents and is also intensively discussed with more than one hundred thousand mentions. If we ignore development frameworks and utilities, and focus only on software specific to GenAI (in bold in Table 3), around half of the highly cited software in the top 20 are proprietary and all from OpenAI (ChatGPT, GPT, Codex).

The dominant software mentioned in scientific publications is ChatGPT, with other software specific to GenAI highlighted in orange.

Table 3 Top 20 software mentioned in the open access subset of the GenAI corpus (a total of 34,183 successfully downloaded PDFs)

	Software name	Citing documents	Total mentions
1	ChatGPT	4,783	137,822
2	PyTorch	3,832	5,566
3	TensorFlow	1,627	2,602
4	CycleGAN	1,077	12,655
5	AlphaFold	1,005	13,528
6	GPT	859	18,370
7	ADAM	855	1,816
8	scikit-learn	853	1,187
9	MATLAB	730	1,492
10	AdamW	649	891
11	StyleGAN	635	3,310
12	Keras	583	878
13	pix2pix	518	1,117
14	Huggingface	507	936
15	GitHub	506	2,235
16	Mechanical Turk	451	714
17	Linux	396	624
18	Codex	380	3,868
19	StarGAN	377	2,716
20	Windows	377	564

Source: WIPO.

2 Global patenting and research in GenAI

Advances in deep learning techniques and increasing computing power have spurred the development of GenAI in recent years. Analysis of patents and scientific publications shows that GenAI is booming across the world and this chapters highlights the top GenAI patent owners, the key inventor locations, and where GenAI patent protection is being sought.

Global development

The following chapters give an overview of patenting activity as well as the development of scientific publications in the field of GenAI. For patents, all patent family publications relevant for GenAI were identified and analyzed based on patent data from IFI Claims patent database (see Appendix A.1 for a detailed methodology). A patent family is a collection of patent applications covering the same or similar technical content (i.e. the same invention). We conduct our analysis using patent families to count inventions and not several patents corresponding to the same subject matter and filed in different jurisdictions. For the analysis of scientific publications, we used The Lens (Cambia 2024) as a bibliographical analytics tool, which has an extensive coverage of scientific publications (see Appendix A.6 for the main search query).

Advances in deep learning techniques and increasing computing power have spurred the development of GenAI in recent years. The significant advances in GenAI are reflected in the sharp increase in patent activity in the field. Over the last 10 years, the number of published patent families in GenAI models has increased from less than 800 in 2014 to more than 14,000 in 2023. There has been a big surge in patent activity beginning in 2017, with an average annual growth of around 45% since then. This coincides with the introduction of transformers in 2017. In total, the patent search identified 54,358 patent families published in the field of GenAI between 2014 and 2023. Around 89% of this patent dataset (48,398 patent families) were considered active at the end of 2023.

After the introduction of transformer models in 2017, both patent and scientific publications increased greatly, with scientific publications exploding after the 2022 release of ChatGPT.

Figure 10 Development of global patent families and scientific publications in GenAI, 2014–2023

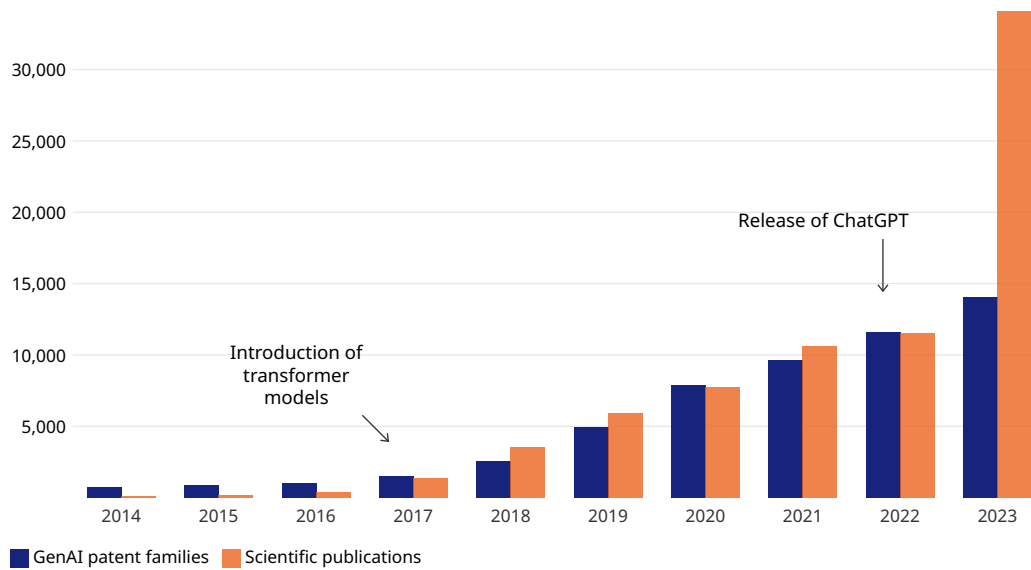

Source: WIPO, based on patent data from EconSight/IFI Claims, April 2024, and publications data from The Lens, January 2024.

The number of scientific publications has risen even more over the same period, from only around 100 in 2014 to more than 34,000 in 2023. In 2023 particularly, there has been a strong increase in scientific publications. It is likely that the release of very successful and popular GenAI models and tools in 2022 (ChatGPT, Stable Diffusion, LLaMA, etc.) has initiated a new wave of GenAI research. A lot of the most recent research appears to be focused on reducing the size of large generative models, on better controlling the generation process and on exploring various applications and domains.

Patent family publications have also risen in 2023, but not as much as scientific publications. It can be expected though that there will be a similar acceleration for patent family publications in 2024 and 2025, as there is generally an 18-month lag between the filing and publication of new patents (WIPO 2021).

GenAI is still a relatively small part of AI, but is becoming more and more important

When comparing the development of GenAI patent family publications with all AI patent family publications since 2014, it is clear that GenAI is still only a relatively small part of all AI research activity. In 2023, there were 14,080 GenAI patent family publications compared to almost 230,000 AI patent family publications in total. However, since 2017 we can see that the GenAI share of all AI patents has been increasing (from 4.2% in 2017 to 6.1% in 2023) (Figure 11).

Given the massive increase in public interest in GenAI since the ChatGPT launch in November 2022, as well as the explosion of scientific publications in 2023, it is likely that GenAI will also continue to become more and more important in the patent world within the AI field. Given the time lag between the filing and publication of new patents mentioned above, the recent increase in GenAI research activity is likely to become more visible in patent data from 2024 onwards.

The share of GenAI patent publications among all AI patents has shown a slight uptick since 2017, from 4.2% to 6.1% in 2023, and will likely further increase in future.

Figure 11 Share of GenAI of total AI patent family publications, 2014–2023

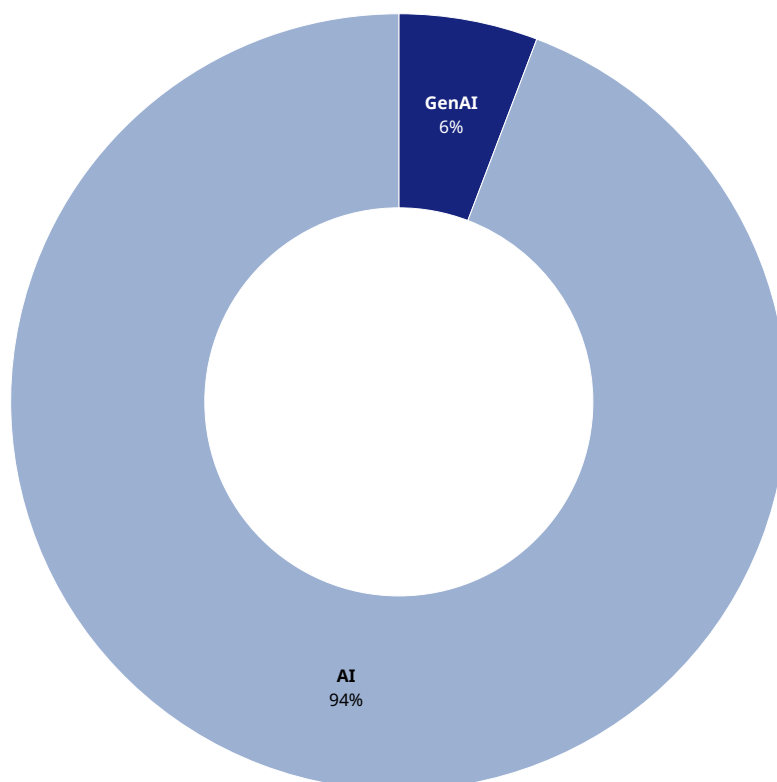

■ GenAI ■ AI

Source: WIPO, based on patent data from EconSight/IFI Claims, April 2024.

Top patent owners

The Chinese companies Tencent, Ping An Insurance Group and Baidu published the most GenAI patent families in the last 10 years (Figure 12). Tencent has launched its own AI chatbot based on its LLM “Hunyuan,” which supports image creation, copywriting and text recognition, among other applications (Tencent 2023). The company uses “Hunyuan” to add AI capabilities to its flagship products such as WeChat to improve the user experience. Ping An Insurance’s AI initiatives focus on GenAI models for underwriting and risk assessment (MarketsandMarkets 2023). Baidu was one of the earliest players in the GenAI space and recently released its latest LLM-based AI chatbot, ERNIE 4.0. Baidu has also developed multiple LLMs for industries such as IT, Transport or Energy (Triolo and Perera 2023).

Although corporations dominate as the largest patent owners, the Chinese Academy of Sciences, a research organization is fourth in the list, above IBM (research organizations shown in bold).

Figure 12 Top patent owners in GenAI, 2014–2023

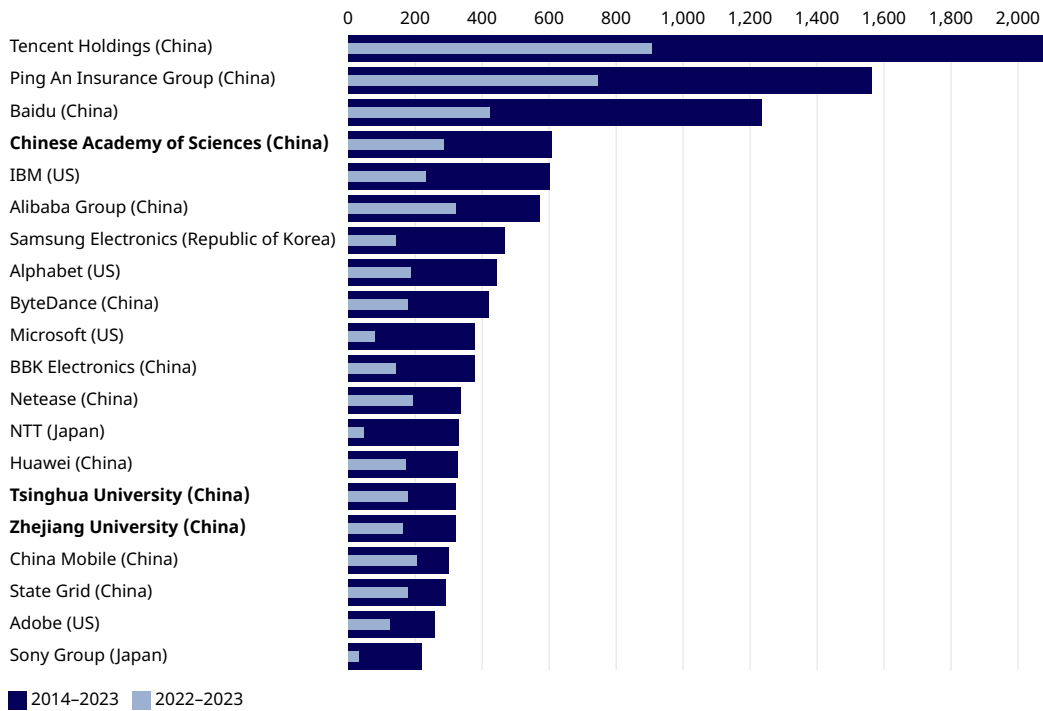

Note: Published patent families in GenAI.

Source: WIPO, based on patent data from EconSight/IFI Claims, April 2024.

The Chinese Academy of Sciences (fourth), the Tsinghua University (15th) and the Zhejiang University (16th) are the only research organizations in the top 20 ranking. Alibaba Group (sixth), ByteDance (ninth), BBK Electronics (11th), Netease (12th), Huawei (14th), China Mobile (17th) and State Grid (18th) are other Chinese companies in the top 20.

IBM (fifth), Alphabet/Google (eighth), Microsoft (10th) and Adobe (19th) are the top US companies in GenAI in terms of patent families. IBM has developed a GenAI platform, watsonx, which enables companies to use and customize LLMs with a focus on data security and compliance, as companies can build AI models trained on their own data (Stack Overflow 2023). Alphabet's AI division DeepMind recently unveiled its latest LLM model, Gemini, which will eventually be integrated into Google's search engine, advertising products, Chrome browser and other products (Pichai and Hassabis 2023). Microsoft is a major player in GenAI, not only through its large investment in OpenAI, but also through other research activities. For example, Microsoft's InnerEye project analyses medical scans to detect abnormalities, diagnose diseases and recommend treatment plans (Microsoft 2024).

Rounding off the top 20 are the electronics conglomerate Samsung Electronics (seventh) (Republic of Korea) and the Japanese companies NTT (13th) and Sony Group (20th). Samsung recently announced the development of Samsung Gauss, a GenAI model that can compose emails, summarize documents and translate text, which the company plans to integrate into its mobile phones and smart home appliances (Yoon 2023).

Does OpenAI have any patents?

Because of the success of ChatGPT, OpenAI has become a synonym for GenAI in the public eye. However, OpenAI does not appear to have filed any patents for its research activities until the beginning of 2023. An explanation for this might be the non-profit origin of OpenAI. Originally, OpenAI was founded as a non-profit organization that encouraged its researchers to publish and share their work to “digital intelligence in the way that is most likely to benefit humanity as a whole” (Brockmann and Sutskever 2015). OpenAI initially made open-source significant parts of its technology. The company later transitioned from non-profit to a “capped” for-profit model (with a split of OpenAI into the non-profit OpenAI, Inc and the for-profit subsidiary OpenAI Global, LLC with Microsoft as one of the key investors). An alternative explanation might be that OpenAI is opting to retain its IP in the form of trade secrets.

OpenAI seemed first to protect parts of its technology with trade secrets (Keseris and Kovarik 2023). However, six US patents from OpenAI were published in the first quarter of 2024 (three granted and three pending), filed in early 2023, indicating a change of IP strategy and the creation of a patent portfolio.

As this patent landscape report shows, most large tech companies have filed numerous GenAI patents over the past decade to protect future revenues against license assertions. OpenAI’s lack of patents could therefore pose a risk for their IP strategy (LexisNexis 2023) and their recent patenting activity indicates their need for a defensive patent strategy.

A closer look at research activities of research organizations around the globe shows that the Chinese Academy of Sciences has by far the most extensive patent activity. The Chinese institution has published more than 600 patent families since 2014, almost twice as many as second- and third-ranked Tsinghua University and Zhejiang University. The Chinese Academy of Sciences launched its latest LLM model, “Zidong Taichu 2.0,” in the summer of 2023 which supports various data types including video and 3D.

In total, eight of the top 10 and nine of the top 20 research organizations are Chinese.

Apart from Chinese universities, there are four US universities (University of California, Northwestern University, Stanford University, Arizona State University), three research organizations from the Republic of Korea (National Research Council of Science and Technology, Korea Advanced Institute of Science and Technology, Seoul National University), three Japanese research organizations (National Institute of Information and Communications Technology, University of Tokyo, Osaka University) and one Swiss university (Eidgenössische Technische Hochschule Zürich) in the top 20 (Figure 13).

There is a dominance of Chinese universities/research organizations along with a few from the US, Republic of Korea, Japan, and Switzerland in the top 20 patent owners among universities/research organizations.

Figure 13 Top patenting universities/research organizations in GenAI, 2014–2023

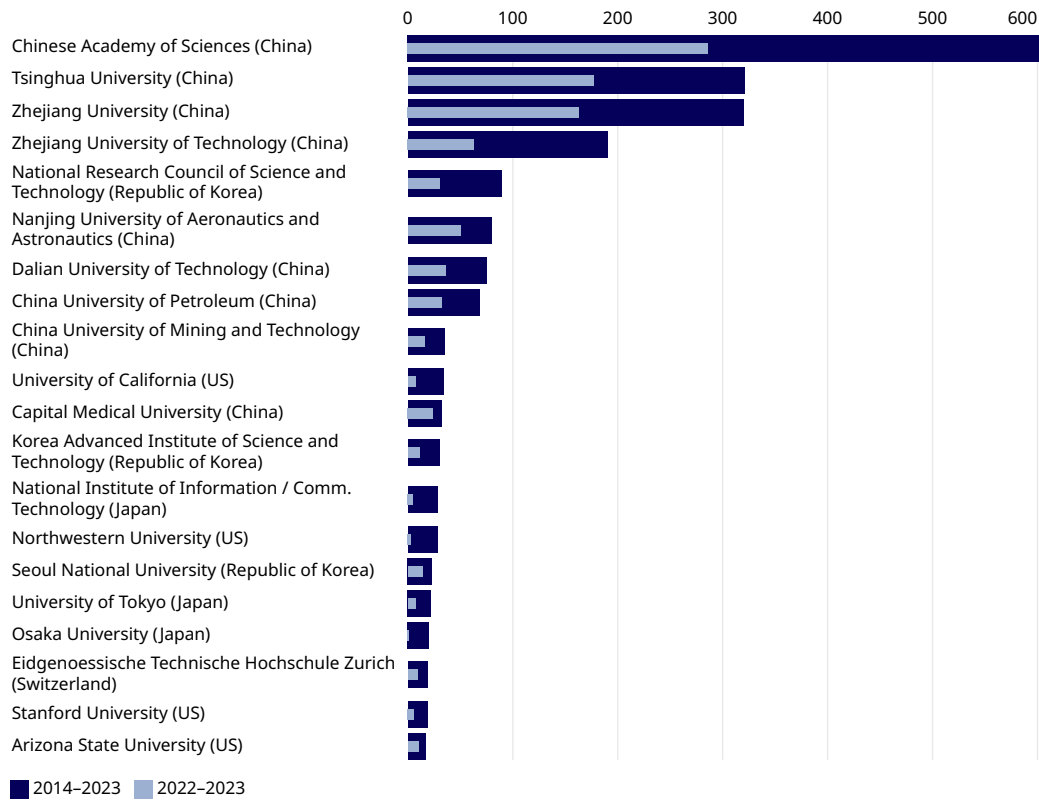

Note: Published patent families in GenAI.

Source: WIPO, based on patent data from EconSight/IFI Claims, April 2024.

Regarding the top institutions in terms of a count of scientific publications, China and the US dominate with several research organizations in the top 20 (China has eight, the US six). In addition, there are four universities from the UK and one each from Canada and Japan in the top 20 (Figure 14).

Again, the Chinese Academy of Sciences is clearly ahead with more than 1,100 scientific publications since 2010. Tsinghua University and Stanford University follow in positions 2 and 3 with more than 600 scientific publications each. Alphabet/Google (fourth) is the only company that ranks in the top 20 institutions with 556 scientific publications.

Only one corporation, Alphabet (parent company of Google), is among the top 20 largest entities with scientific publications, the rest being universities/research organizations.

Figure 14 Number of GenAI scientific publications for the top 20 institutions, 2010–2023

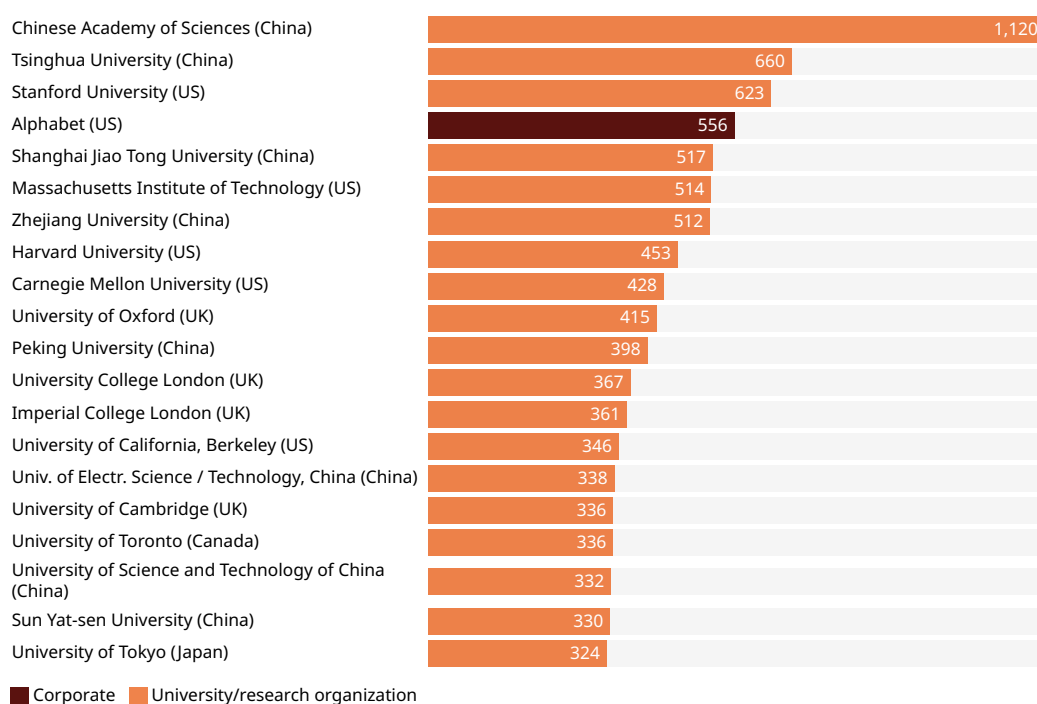

Source: WIPO, based on data from The Lens, January 2024.

However, the raw number of publications as a performance indicator has its limitations, because it does not reflect the impact of the publications. The number of citations that a publication receives is therefore often considered as a more reliable indicator. The citation numbers by institution show higher positions for companies. Alphabet/Google becomes the leading institution by a large margin, and seven other companies are present in the top 20 (Figure 15). The case of OpenAI is also noteworthy. The company has published only 48 articles according to the GenAI corpus (325th institution in term of document count), but these publications received a total of 11,816 citations from other publications of the corpus (position 13 in total). Such impact is outstanding in our study, in particular given that many of OpenAI's publications are pre-prints and not published in major conferences and journals.

Although Alphabet/Google is fourth in terms of number of scientific publications, these publications have been cited the most, indicating the company's great impact in advancing the technology.

Figure 15 Number of citations to GenAI scientific publications for the top 20 institutions, 2010–2023

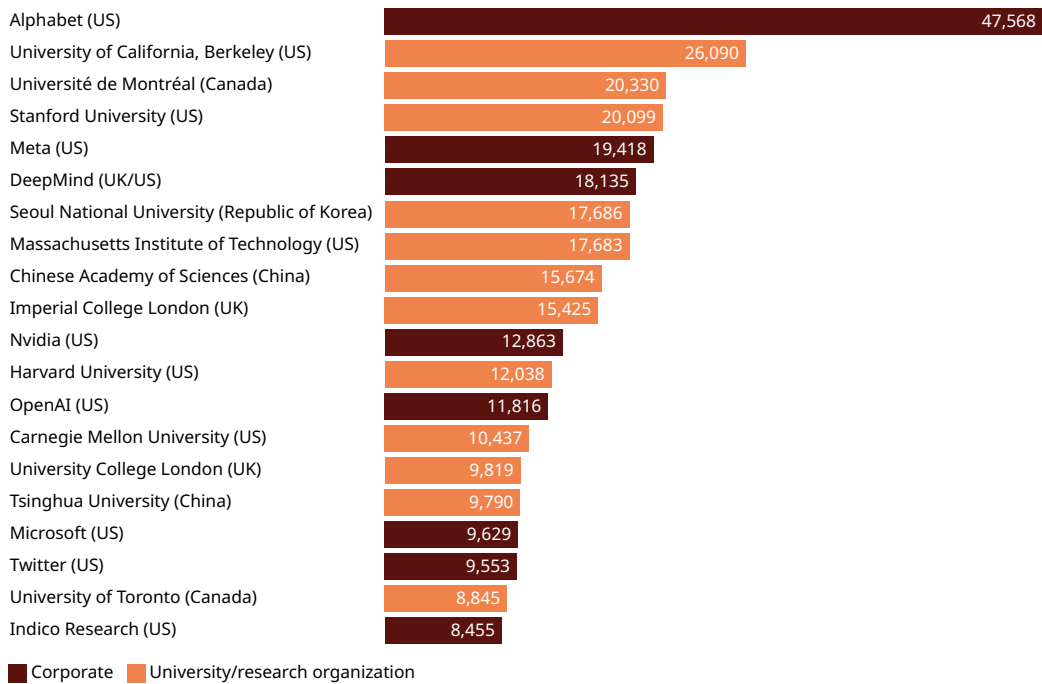

Source: WIPO, based on data from The Lens, January 2024.

Key locations of inventors

China is at the forefront of global patenting activity in GenAI. China was responsible for more than 38,000 patent family publications between 2014 and 2023, based on the inventor addresses published on patents. Since 2017, China has published more patent families in this field every year than all other countries combined.

With a total of around 6,300 patent families between 2014 and 2023, the US is the second most important research location for GenAI. The Asian countries of the Republic of Korea, Japan and India are also important research locations in GenAI, all ranking in the top 5 countries worldwide (third, fourth and fifth respectively) (Figure 16).

The UK is the leading European location (sixth on a global level), having published 714 patents in the same period. However, Germany is close behind (708 patent families) and has published more GenAI patents than the UK in recent years.

These seven inventor locations account for the majority of patenting activity related to GenAI, contributing around 98 percent of the dataset, with a few contributions from other countries such as Canada, Israel and France.

Although China-based inventors dominate, inventors from other locations, such as the Republic of Korea and India, are also among the top locations for GenAI inventions.

Figure 16 Development of GenAI patent families in key inventor locations, 2014–2023

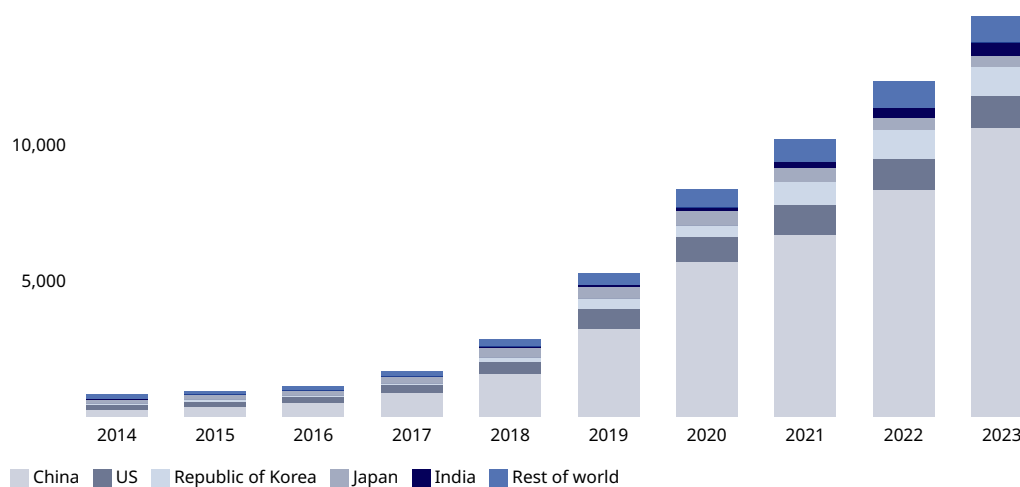

Source: WIPO, based on patent data from EconSight/IFI Claims, Orbit by Questel and PATENTSCOPE, April 2024.

Figure 17 gives an overview of the current Chinese leadership in GenAI research activities. Between 2014 and 2023, China achieved a world share of almost 70% of all patent family publications in GenAI globally (Y-axis). Even more impressive is that China has also reached very high average growth rates of patent family publications (50% per year, X-axis) in that period among the top inventor locations despite its already large GenAI patent portfolio. Only India had even higher growth rates in GenAI patent family publications (56% per year). The Republic of Korea has also achieved high growth rates in their GenAI patent families since 2014. By contrast, patent families from Japan and the UK have only risen by a little more than 10% per year on average.

Not only does China have the largest share of all patent families published globally but also is growing at the rate of 50% per year. However, India has an even higher growth rate of 56% per year even though its world share is still small.

Figure 17a Country comparison of the number of GenAI-related patent families, 2014–2023

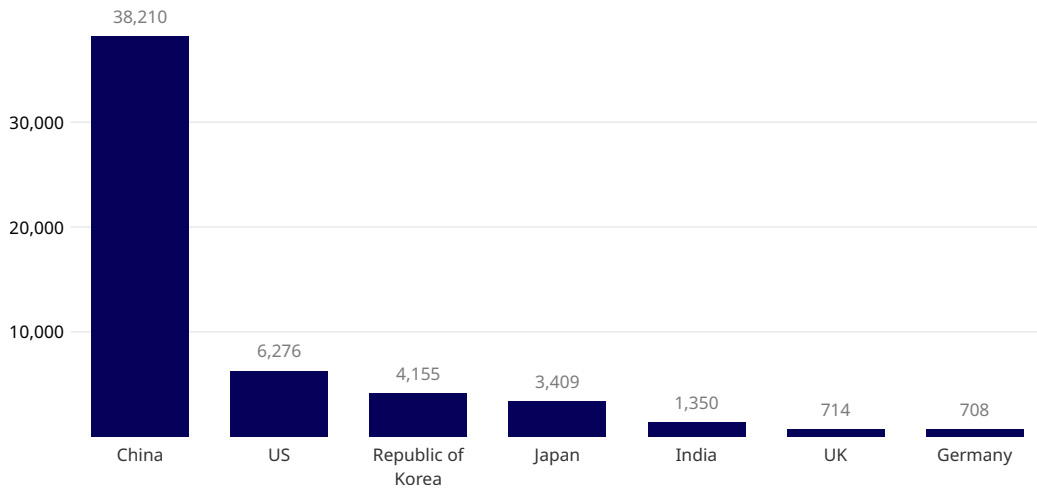
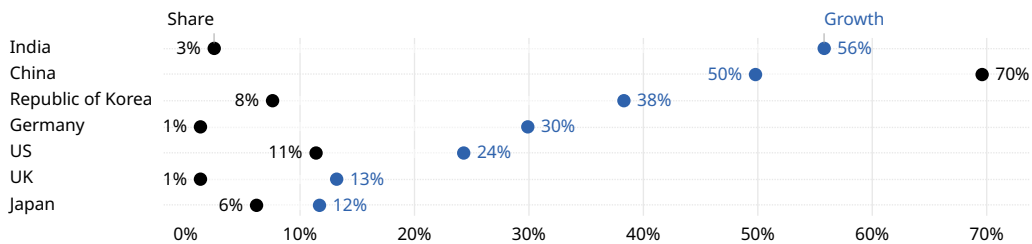

Figure 17b Country comparison of the share and growth rate of GenAI-related patent families, 2014–2023



Source: WIPO, based on patent data from EconSight/IFI Claims, Orbit by Questel and PATENTSCOPE, April 2024.

Regarding scientific publications, China and the US largely dominate and are at a similar level in terms of publications (Figure 18).

Both China and the US dominate scientific publications, both publishing at similar levels. Figure 18 Number of GenAI scientific publications in the top 10 countries, 2010–2023

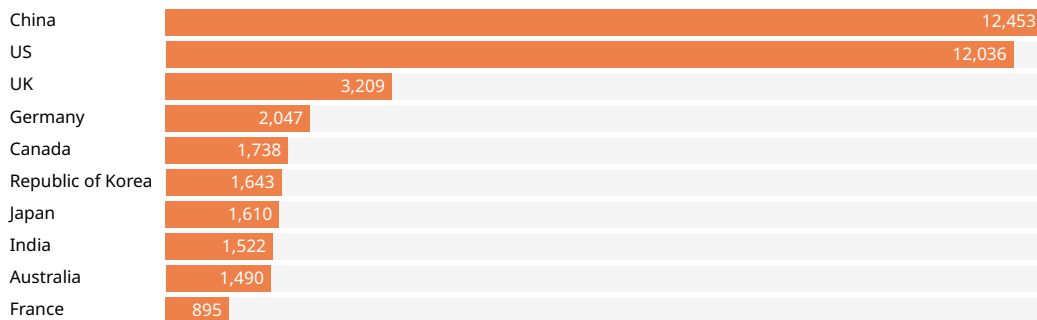

Source: WIPO, based on data from The Lens, January 2024.

Figure 19 shows that China and the US, despite being comparable in terms of the number of publications, differ strongly in terms of citations. Scientific publications with at least one affiliation in the US received significantly more citations globally than those with at least one Chinese affiliation.

Scientific publications with at least one affiliation in the US received significantly more citations globally than those with at least one Chinese affiliation.

Figure 19 Number of citations of GenAI scientific publications in the top 10 countries, 2010–2023

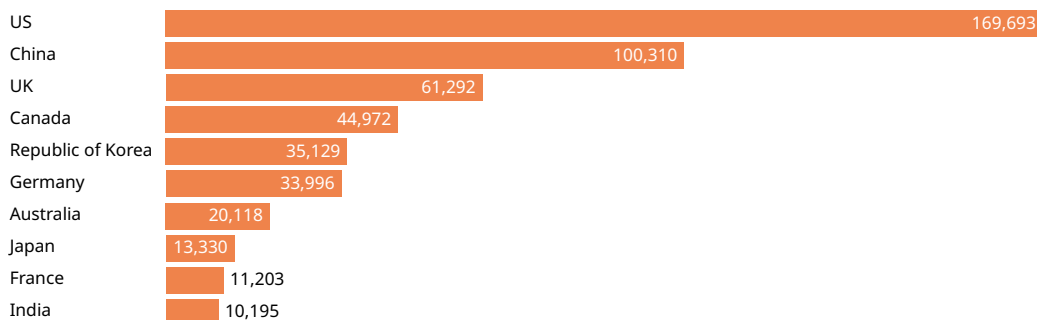

Source: WIPO, based on data from The Lens, January 2024.

Key filing jurisdictions

An analysis based on filing jurisdictions of GenAI patent families provides an additional perspective. Members of patent families can be filed directly in one or more countries, via national patent offices, via the Patent Cooperation Treaty (PCT) route administered by WIPO or via the European Patent Convention route (EP) administered by the European Patent Office.

Figure 20 shows that China is not only the leading inventor location in terms of GenAI patent families, but also the top country in terms of patent filings. Between 2014 and 2023, more than 40,000 GenAI patent families were filed in China for seeking patent protection. In the US, the number of patent families filed in the country reached more than 10,700 over the last decade.

It is also worth noting that the Patent Cooperation Treaty (PCT) and the European Patent Convention (EP) are relevant routes for GenAI inventors to seek patent protection. Over the last decade, there have been more than 7,700 patent filings under the Patent Cooperation Treaty and more than 3,100 patent filings under the European Patent Convention.

China is not only the leading inventor location in terms of GenAI patent families, but also the top jurisdiction where patents were filed.

Figure 20 Key patent filing jurisdictions in GenAI, 2014–2023

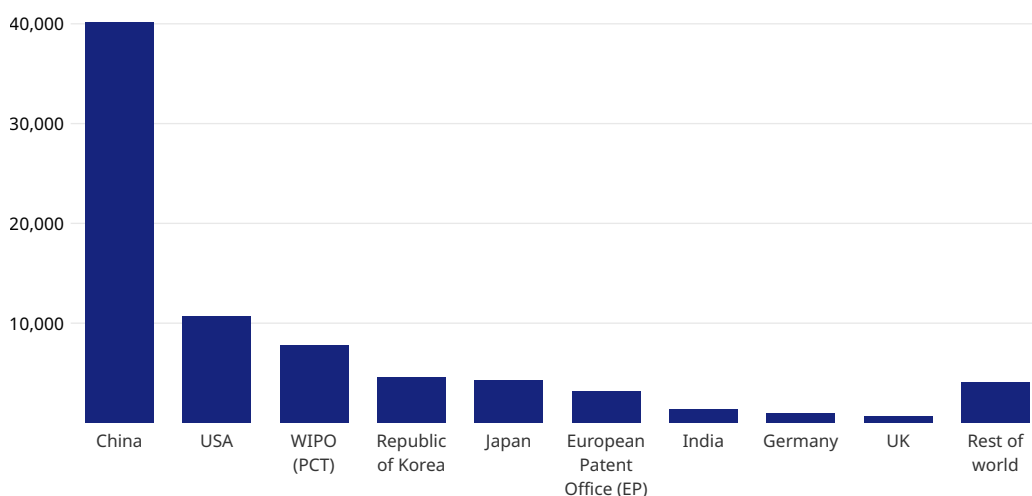

Note: Members of patent families can be filed in several countries.

Source: WIPO, based on patent data from EconSight/IFI Claims, Orbit by Questel, PATENTSCOPE and PatentSight, April 2024.

3 Patent trends in GenAI models

Large language models (LLMs) is a term that is now synonymous with Generative AI, generative adversarial networks (GANs), variational autoencoders (VAEs) and diffusion models are all different types of GenAI models. This chapter provides a summary of the main patent trends around different GenAI models.

Global development

In recent years, several different GenAI models have been developed (see previous chapters). All identified GenAI patent families were assigned to five different model types based on information from patent abstract, claims or title. However, it must be noted that a large proportion of all GenAI patent families do not fit into any specific model type. Many GenAI patents do not include keywords about the specific model used in the patent abstract, claims or title, but instead focus on describing the use case for the patent and only give a generic description of the GenAI processes used. This makes it difficult to find and map the patents to the five core GenAI models, which also have some overlaps in content. As a result, only about 25% of all GenAI patent family publications since 2014 can be mapped to one of the five models.

Among the core models of GenAI, many patent families belong to the category of generative adversarial networks (GANs). Between 2014 and 2023, there were almost 9,700 publications of patent families in this model type with almost 2,400 patent families published in 2023 alone. Variational autoencoders (VAE) and large language models (LLMs) are the second and third largest models in terms of patent families with around 1,800 and 1,300 new patent families between 2014 and 2023 (Figure 21).

The largest number of patents were published in the area of GANs.

Figure 21 Development of global patent families in five GenAI core models, 2014–2023

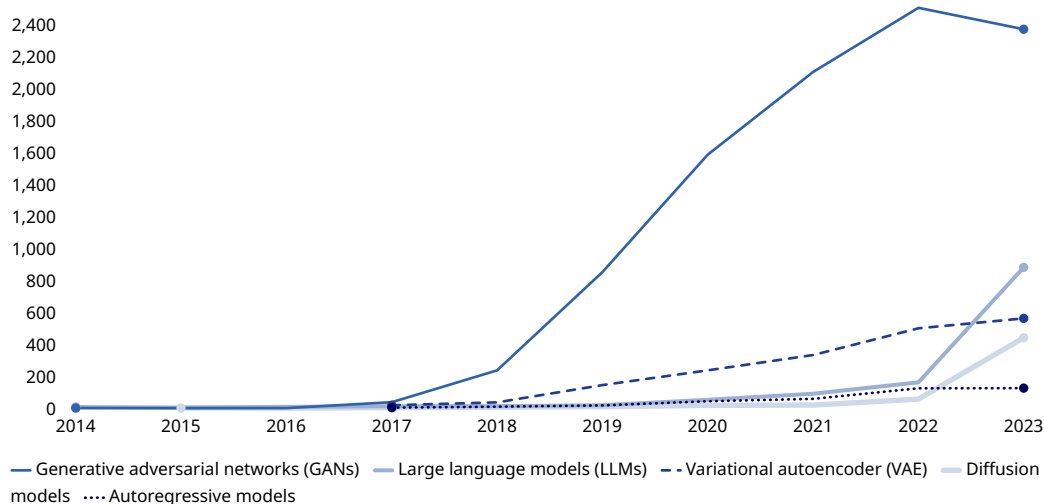

Source: WIPO, based on patent data from EconSight/IFI Claims, April 2024.

In terms of patent growth, patent families assigned to GANs show the strongest increase over the past decade. However, patent growth of GAN patent families has slowed down and GAN patent families have increased only moderately over the last three years. A similar slowdown in patent growth can be seen for patent families for VAE models and autoregressive models. In contrast, diffusion models and LLMs show much higher growth rates over the last three years, with the number of patent families for diffusion models increasing from 18 in 2020 to 441 in 2023 and for LLMs increasing from 53 in 2020 to 881 in 2023. The GenAI boom caused by modern chatbots such as ChatGPT has clearly increased research interest in LLMs.

Over the past decade, patent growth was weakest in autoregressive models (Figure 22). However, it should be noted that there is some overlap in the content of the different GenAI models and some patent families belong to more than one model. For example, there is overlap between autoregressive models and large language models, as LLMs are by definition autoregressive models, but not all autoregressive models are LLMs. As patent terminology changes over time, it is likely that due to the strong increase in popularity of large language models, newer patent families are more likely to use the term large language model instead of autoregressive model in patent titles, claims and abstracts. This would explain the weaker growth dynamics in patents for autoregressive models.

Although patent publications in GANs dominated up to 2020, it has slowed down since and patent publications in diffusion models have grown tremendously since 2021.

Figure 22 Average annual growth of patent families in the different GenAI models

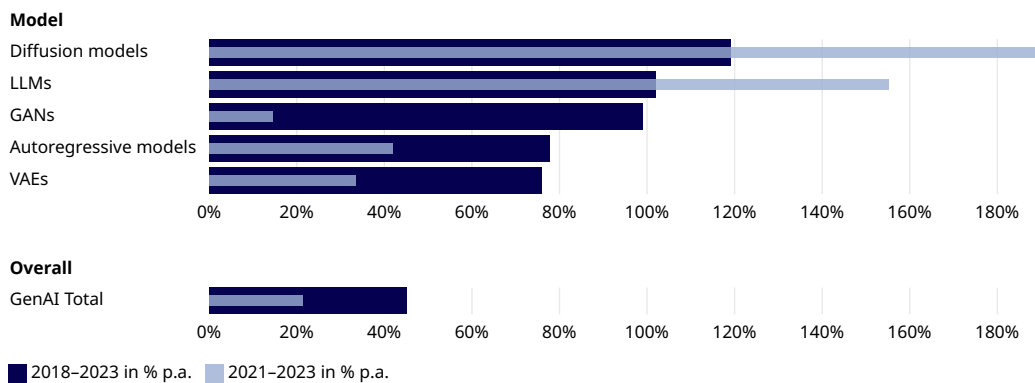

Source: WIPO, based on patent data from EconSight/IFI Claims, April 2024.

Top patent owners

When analyzing the five identified key GenAI models, Tencent tops the list for decoder-based LLM patent families, followed by Baidu. Baidu and Tencent are also the leaders in diffusion models among companies worldwide. Ping An Insurance Group has a comprehensive GenAI patent portfolio, with many patent families in all five GenAI models. State Grid is the leader in terms of GAN patent families (Table 4).

Alphabet/Google has recently significantly increased its number of LLM-related patent families and is the world's number two for VAE models. IBM is the leader in VAE patent families and number two in GAN models, behind Baidu.

Most companies own patents in one dominant GenAI model, however, there are some exceptions such as Tencent and Google who have filed patents in several model types.

Table 4 Top patent owners in GenAI models (companies), 2014–2023

	GAN	LLM	VAE	Diffusion models	Autoregressive models	GenAI Total
Tencent Holdings (China)	83	96	11	25	13	2,074
Ping An Insurance (China)	90	23	23	15	17	1,564
Baidu (China)	108	65	16	19	10	1,234
IBM (US)	102	9	37	2	0	601
Alibaba Group (China)	17	40	3	13	2	571
Samsung Electr. (Republic of Korea)	67	2	16	0	0	468
Alphabet/Google (US)	43	31	32	4	14	443
ByteDance (China)	40	2	2	1	3	418
Microsoft (US)	23	8	15	0	3	377
BBK Electronics (China)	33	5	0	1	0	377
Netease (China)	6	9	4	1	3	337
NTT (Japan)	10	3	12	0	1	330
Huawei (China)	42	20	9	3	3	328
China Mobile (China)	36	1	3	1	1	300
State Grid (China)	129	3	20	3	1	291
Adobe (US)	88	4	8	1	1	257
Sony Group (Japan)	19	1	6	0	0	218
Siemens (Germany)	78	1	18	4	3	208
Ant Group (China)	17	10	7	7	3	202
Industrial and Commercial Bank of China (China)	23	10	3	1	0	191

Note: The table shows published GenAI patent families between 2014 and 2023. A large proportion of GenAI patents does not fit into any of the specific models, as these patents do not contain keywords relating to the specific model used in the patent abstract, claims or title. Therefore, the total number of GenAI patent families is larger than the sum of the five models.

Source: WIPO, based on patent data from EconSight/IFI Claims, April 2024.

On the level of the five GenAI models, the Chinese Academy of Sciences is leading among research organizations in GAN models, VAE models and autoregressive models (Table 5). Zhejiang University is the frontrunner in patent activity in diffusion models. Tsinghua University has published the most patent families for LLMs.

Similar to companies, universities/research organizations file patents in predominantly one type of model, with GAN being the most preferred type.

Table 5 Top patent owners in GenAI models (universities/research organizations), 2014–2023

	GAN	LLM	VAE	Diffusion models	Autoregressive models	GenAI Total
Chinese Academy of Sciences (China)	191	7	28	14	10	607
Tsinghua University (China)	65	19	23	11	4	321
Zhejiang University (China)	97	10	24	20	5	320
Zhejiang University of Technology (China)	97	1	7	5	0	190
National Research Council of Science and Technology (Republic of Korea)	15	3	2	0	1	89
Nanjing University of Aeronautics and Astronautics (China)	55	0	6	0	0	80
Dalian University of Technology (China)	35	0	4	1	0	75
China University of Petroleum (China)	41	0	3	1	4	68
China University of Mining and Technology (China)	19	0	2	0	0	35
University of California (US)	16	1	4	0	0	34
Capital Medical University (China)	7	0	1	3	0	32
Korea Advanced Institute of Science and Technology (Republic of Korea)	4	0	1	1	0	30
National Institute of Information and Communications Technology (Japan)	0	1	0	0	1	28
Northwestern University (US)	13	0	0	0	1	28
Seoul National University (Republic of Korea)	8	0	0	0	1	23
University of Tokyo (Japan)	1	1	0	0	1	22
Osaka University (Japan)	1	0	0	0	0	20
Eidgenössische Technische Hochschule Zürich (Switzerland)	3	0	2	0	0	19
Stanford University (US)	5	1	2	0	0	19
Arizona State University (US)	4	0	0	1	0	17

Note: The table shows published GenAI patent families between 2014 and 2023. A large proportion of GenAI patents does not fit into any of the specific models, as these patents do not contain keywords relating to the specific model used in the patent abstract, claims or title. Therefore, the total number of GenAI patent families is larger than the sum of the five models.

Source: WIPO, based on patent data from EconSight/IFI Claims, April 2024.

Key locations of inventors

On a country level, China dominates in all five GenAI models in terms of patent families. The Chinese lead is particularly pronounced in diffusion models, where China has published more than 14 times as many patent families since 2014 as the second largest inventor location, the US (500 patent families compared to 35 patent families). China also has a very high global share of patents in the field of autoregressive models (Table 6).

The US is particularly strong in VAEs and LLMs. A large part of the GenAI patents from the Republic of Korea fall into the category of GAN models. For Japan, it is noteworthy that the vast majority of GenAI patent families cannot be linked to any of the five core GenAI models.

In India, GAN patent families accounted for a relatively high proportion of total GenAI patents. In the UK, many patent families belong to the GAN and VAE categories. Germany has a relatively strong research presence in GAN and VAE models.

Patent publications in GANs outnumber patents in other models in all the top inventor locations.

Table 6 Published patent families in GenAI models in top inventor locations, 2014–2023

	GAN	LLM	VAE	Diffusion models	Autoregressive models	GenAI Total
China	7,384	992	1,164	500	295	38,210
USA	1,128	150	346	35	59	6,276
Republic of Korea	634	52	90	14	9	4,155
Japan	126	24	78	5	12	3,409
India	140	8	31	1	3	1,350
UK	85	13	58	1	8	714
Germany	153	11	72	3	4	708

Note: A large proportion of GenAI patents does not fit into any of the specific models, as these patents do not contain keywords relating to the specific model used in the patent abstract, claims or title. Therefore, the total number of GenAI patent families is larger than the sum of the five models.

Source: WIPO, based on patent data from EconSight/IFI Claims, Orbit by Questel and PATENTSCOPE, April 2024.

4 Patent trends in GenAI modes

Generative AI models are very effective for a variety of applications. Mature models support different types of input and output data (modes) and are not limited to text and images, making GenAI potentially relevant to many economic areas. This chapters explores the patent trends for different GenAI modes, from image and video to molecules, genes and proteins.

Global development

GenAI models can use many different types, or modes, of input and output data, such as text, image/video, voice and so on.

Among the different GenAI modes, most patent families belong to the image/video category. Between 2014 and 2023, there were almost 18,000 patent families in this mode, with more than 5,100 patent families in 2023 alone. Patent families that contain the processing of text and speech/sound/music are the third and fourth largest modes in terms of patent families, with almost 13,500 families each over the same period. So far, there are far fewer patent families in the remaining modes 3D image models, chemical molecules/genes/proteins and code/software (Figure 23).

However, similar to patents regarding GenAI models, a large number of patent families (around 14,300 patent family publications between 2014 and 2023) cannot be clearly assigned to any specific data type. In addition, some patent families are assigned to more than one mode as an increasing amount of GenAI models such as MLLMs are overcoming the limitation of only one type of data input and instead can access knowledge from multiple modalities.

Among the different GenAI modes, most patent families belong to the image/video category.

Figure 23 Development of global patent families in the different GenAI modes, 2014-2023

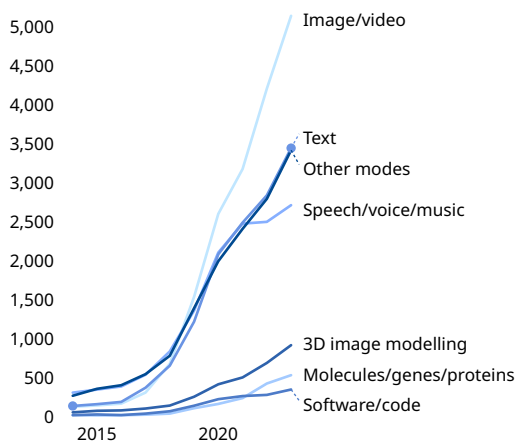

Source: WIPO, based on patent data from EconSight/IFI Claims, April 2024.

In terms of growth of patent families, image/video- and molecules/genes/proteins- based GenAI patent families increased the most over the last decade (an average annual growth rate of around 45% between 2014 and 2023). Molecules/genes/proteins GenAI patent families have also been the growth leaders in recent years. In contrast, the total number of GenAI patent families based on speech/sound/music data has increased only slightly since 2021 (Figure 24).

The highest growth since 2018 has been in patent publications related to molecules/genes/and proteins, including in the last three years since 2021.

Figure 24 Average annual growth of patent families in the different GenAI modes

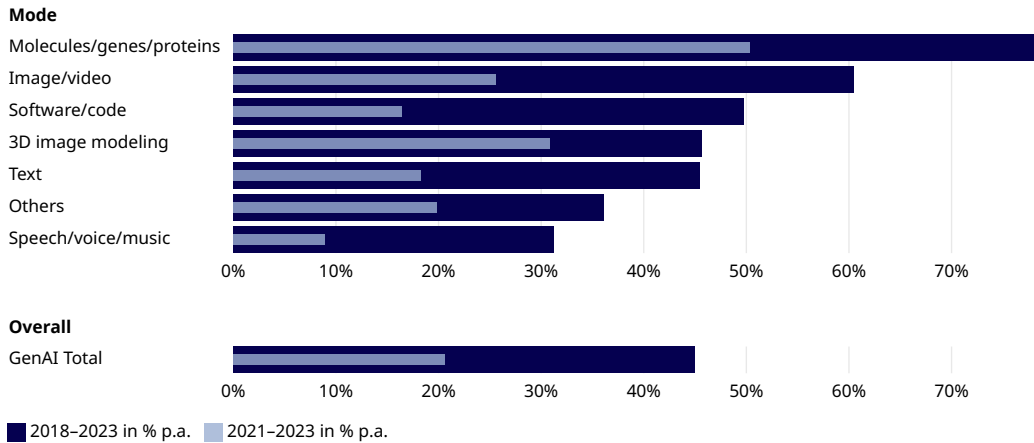

Source: WIPO, based on patent data from EconSight/IFI Claims, April 2024.

Top patent owners

Tencent Holdings is the world leader in terms of published patent families in GenAI modes. The Chinese social media/gaming company is mainly active in GenAI research that processes the data types images/video, text, speech/voice/music as well as other modes. The Chinese companies Ping An Insurance and Baidu are close behind Tencent in terms of patent families and have a similar research pattern, focusing on the same modes (Table 7).

IBM ranks fourth and is the top US company in terms of GenAI patent families. IBM has many GenAI patents based on text processing. In addition, the company is the world leader in GenAI patent families in the software/code category. Samsung is ranked sixth and has a research focus on image/video, text or speech/voice/music based GenAI.

The top European company in terms of GenAI patent families is Siemens (18th), which has many patent families based on image/video data.

Images/video, text, and speech/voice/music are the dominant modes that are being patented.

Table 7 Top patent owners in GenAI modes (companies), 2014–2023

	Images/ video	Text	Speech/ voice/ music	3D image models	Molecules/ genes/ proteins	Software/code	Other modes
Tencent Holdings (China)	607	565	551	102	57	41	464
Ping An Insurance (China)	262	600	599	26	33	24	223
Baidu (China)	395	465	441	81	26	18	166
IBM (US)	101	274	168	13	37	42	132
Alibaba Group (China)	142	213	144	36	2	10	133
Samsung Electr. (Republic of Korea)	173	140	226	34	10	5	57
Alphabet/Google (US)	138	107	200	25	15	15	72
ByteDance (China)	173	82	112	21	6	7	90
Microsoft (US)	78	194	151	18	6	22	42
BBK Electronics (China)	125	58	117	12	0	4	116
Netease (China)	78	76	80	37	0	11	102
NTT (Japan)	37	100	169	11	0	3	62
Huawei (China)	104	84	72	24	1	4	102
China Mobile (China)	79	67	83	10	0	7	89
State Grid (China)	75	54	31	6	1	2	144
Adobe (US)	190	79	34	30	0	9	20
Sony Group (Japan)	87	35	105	42	0	1	42
Siemens (Germany)	124	25	8	10	3	4	59
Ant Group (China)	45	82	29	3	0	6	59
Industrial and Commercial Bank of China (China)	40	62	49	5	0	16	48

Source: WIPO, based on patent data from EconSight/IFI Claims, April 2024.

Looking at the top 20 research organizations in terms of GenAI patent families, the main research organizations have a focus on GenAI activities that process image/video data.

The Chinese Academy of Sciences is far ahead in terms of patent families based on image/video data, and it also holds the top position in most other GenAI modes. The only exceptions are in the 3D Image models category, where Tsinghua University leads the ranking with 32 patent families, and software/code-based GenAI patent families, where Zhejiang University holds the top spot with 10 patent families.

The number of GenAI patent families based on the use of text or speech/voice/music data is lower among most top universities and research organizations. This is in contrast to the research priorities of the top companies. Outliers are the National Research Council of Science and Technology from the Republic of Korea and the Japanese research organizations (National Institute of Information and Communications Technology, University of Tokyo, Osaka University), where the number of GenAI patent families based on speech/voice/music and text data is as high or higher than the number of patents based on image/video data.

Among universities/research organizations, patent publications using images/video as the mode dominate.

Table 8 Top patent owners in GenAI modes (universities/research organizations), 2014–2023

	Images/video	Text	Speech/voice/ music	3D image models	Molecules/genes/ proteins	Software/code	Other modes
Chinese Academy of Sciences (China)	314	107	83	31	30	8	107
Tsinghua University (China)	120	80	29	32	10	3	97
Zhejiang University (China)	156	78	36	24	11	10	63
Zhejiang University of Technology (China)	78	12	10	7	24	6	66
National Research Council of Science and Technology (Republic of Korea)	36	28	34	16	0	1	15
Nanjing University of Aeronautics and Astronautics (China)	48	6	4	0	0	3	24
Dalian University of Technology (China)	39	14	1	5	6	0	23
China University of Petroleum (China)	28	6	1	3	10	1	26
China University of Mining and Technology (China)	27	7	1	1	0	1	4
University of California (US)	20	4	3	1	5	1	4
Capital Medical University (China)	21	2	1	0	0	0	8
Korea Advanced Institute of Science and Technology (Republic of Korea)	22	4	1	3	2	0	4
National Institute of Information and Communications Technology (Japan)	3	9	20	0	0	0	1
Northwestern University (US)	14	8	3	5	0	1	5
Seoul National University (Republic of Korea)	18	2	3	1	1	0	1
University of Tokyo (Japan)	3	5	10	0	0	0	6
Osaka University (Japan)	2	5	14	0	0	0	3
Eidgenössische Technische Hochschule Zürich (Switzerland)	15	0	0	8	1	0	3
Stanford University (US)	8	1	0	1	5	0	5
Arizona State University (US)	7	1	2	0	3	0	4

Source: WIPO, based on patent data from EconSight/IFI Claims, April 2024.

Key locations of inventors

As with GenAI models, China is clearly the leading inventor location for all GenAI modes in terms of patent families that were published over the last decade (Table 9). In each category, more than 50% of all patent families were developed in China. Image/video-based GenAI is a key research area in China with almost 13,000 patent families since 2014. Text, other modes and speech/voice/music are other major GenAI research areas in China. However, the highest patent family growth rates in China were observed for patent families based on molecules/genes/proteins data (annual growth of 64% between 2021 and 2023).

All the top inventor locations follow similar trends in modes that are most patented.

Table 9 Published patent families in GenAI modes in top inventor locations, 2014–2023

	Image/ video	Text	Speech/ voice/ music	3D image models	Molecules/ genes/ proteins	Software/ code	Other modes
China	12,911	9,698	8,919	1,864	920	873	9,767
US	2,146	1,799	1,606	515	330	299	1,449
Republic of Korea	1,332	928	1,258	320	123	52	1,222
Japan	833	608	1,345	212	50	40	1,005
India	243	321	192	42	32	53	181
UK	244	150	180	76	63	23	176
Germany	289	79	105	54	22	21	239

Source: WIPO, based on patent data from EconSight/IFI Claims, Orbit by Questel and PATENTSCOPE, April 2024.

In the US, image/text-based GenAI patent families are the largest category (1,799 patent families since 2014), but the US world share is highest in the categories software/code GenAI and molecules/genes/proteins GenAI. In both categories, more than 20% of all patent families since 2014 were developed in the US.

In both Japan and the Republic of Korea, speech/voice/music is a very important GenAI mode in terms of patent families. However, patent growth rates differ significantly between the two Asian countries. While the growth of GenAI patent families in the Republic of Korea has been very dynamic across all modes in recent years, Japan's GenAI patent families peaked in 2020/2021 and have been declining since then.

Germany has a strong research focus on image, video-based GenAI.

In India, most GenAI patent families are based on text data.

Connection between GenAI models and GenAI modes

There is an interdependence between the use of a specific GenAI model for a certain GenAI application and the use of a specific GenAI mode. This is because some models work particularly well or depend on certain types of data. Our patent analysis (Figure 25) shows that:

- Text is the most commonly used data type for LLMs.
- Speech/voice/music is an important data type for GAN and VAE models.
- GAN models are the most important model type for processing image/video data, 3D image models data and software/code data.
- Molecules/genes/proteins data is mainly processed in GAN and VAE models.
- The category other modes, i.e. data that does not fit into any of the other categories, plays an important role for VAE and GAN models.

Although all types of models are used for the various modes, some modes are processed more using certain models than others.

Figure 25 Interdependence between GenAI models and GenAI modes, 2014–2023

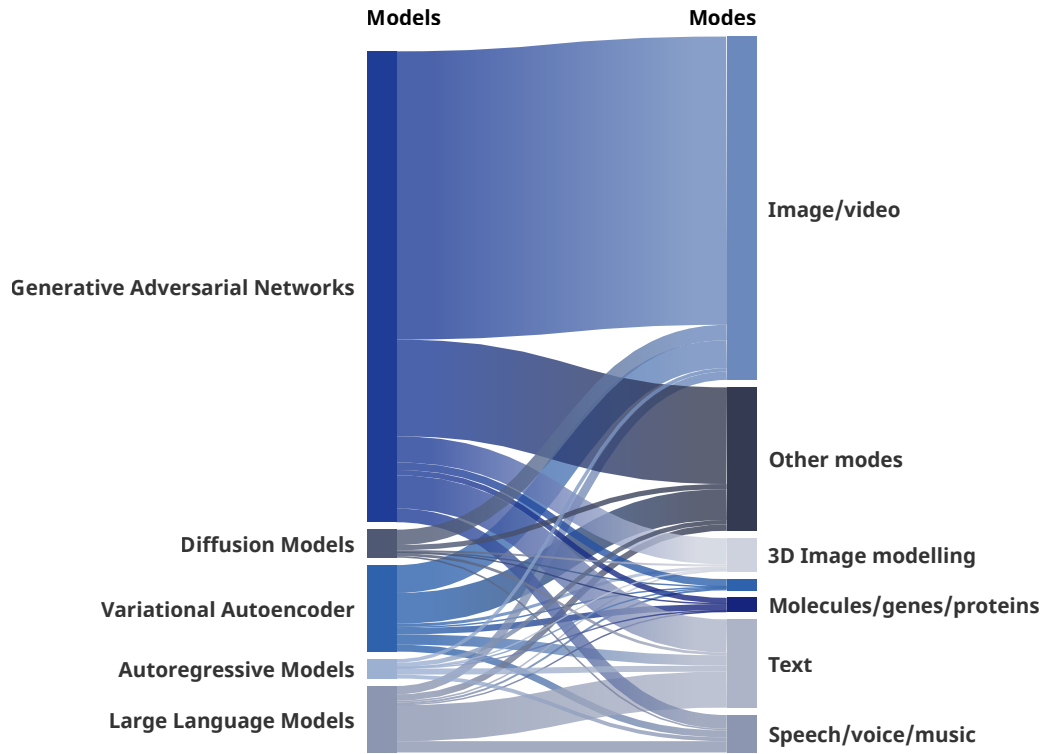

Note: A table with the specific numbers for the connections between GenAI models and modes is included in Appendix A.3.

Source: WIPO, based on patent data from EconSight/IFI Claims, April 2024.

5 Patent trends in GenAI applications

GenAI is bound to have a significant impact on a wide range of industries as it finds its way into products, services and processes, becoming a technological enabler for content creation and productivity improvement. This chapters identifies 21 application areas in the GenAI patent landscape and explores the different trends in these areas.

Global trends

GenAI is expected to have a huge impact across many industries as it finds its way into products, services and processes, becoming a technological enabler for content creation and productivity improvement. For example, a recent study by McKinsey estimates that GenAI could add between US\$2.6 trillion and US\$4.4 trillion annually across a wide range of industry use cases (McKinsey 2023). The firm believes that banking, high tech and life sciences are among the industries that could see the greatest impact from GenAI.

Based on our analysis of GenAI patents, we have identified the applications where research activities are focused on. The following list shows the 21 application areas identified, ranked according to the number of published patent families within the last decade. A short description of current GenAI trends within these applications including patent examples is included in the Appendices.

- Software and other applications
- Life sciences
- Document management and publishing
- Business solutions
- Industry and manufacturing
- Transportation
- Security
- Telecommunications
- Personal devices
- Banking and finance
- Physical sciences and engineering
- Education
- Entertainment
- Arts and humanities
- Computing in Government
- Networks and smart cities
- Industrial property, law, social and behavioral sciences
- Cartography
- Military
- Energy management
- Agriculture

The largest application domain is the software category. However, to note, a large number of patent families cannot be assigned to a specific application and are instead included in the category software/other applications.

Patent families in the other categories are smaller in number, with life sciences in second place (5,346 patent families between 2014 and 2023) and document management and publishing (4,976) in third place (Figure 26). Other notable applications with GenAI patent families ranging from around 2,000 to around 5,000 over the same period are business solutions, industry and manufacturing, transportation, security and telecommunications.

Patents in software/other applications dominate followed by patents in life sciences and document management and publishing.

Figure 26 Development of global patent families in GenAI applications 2014–2023

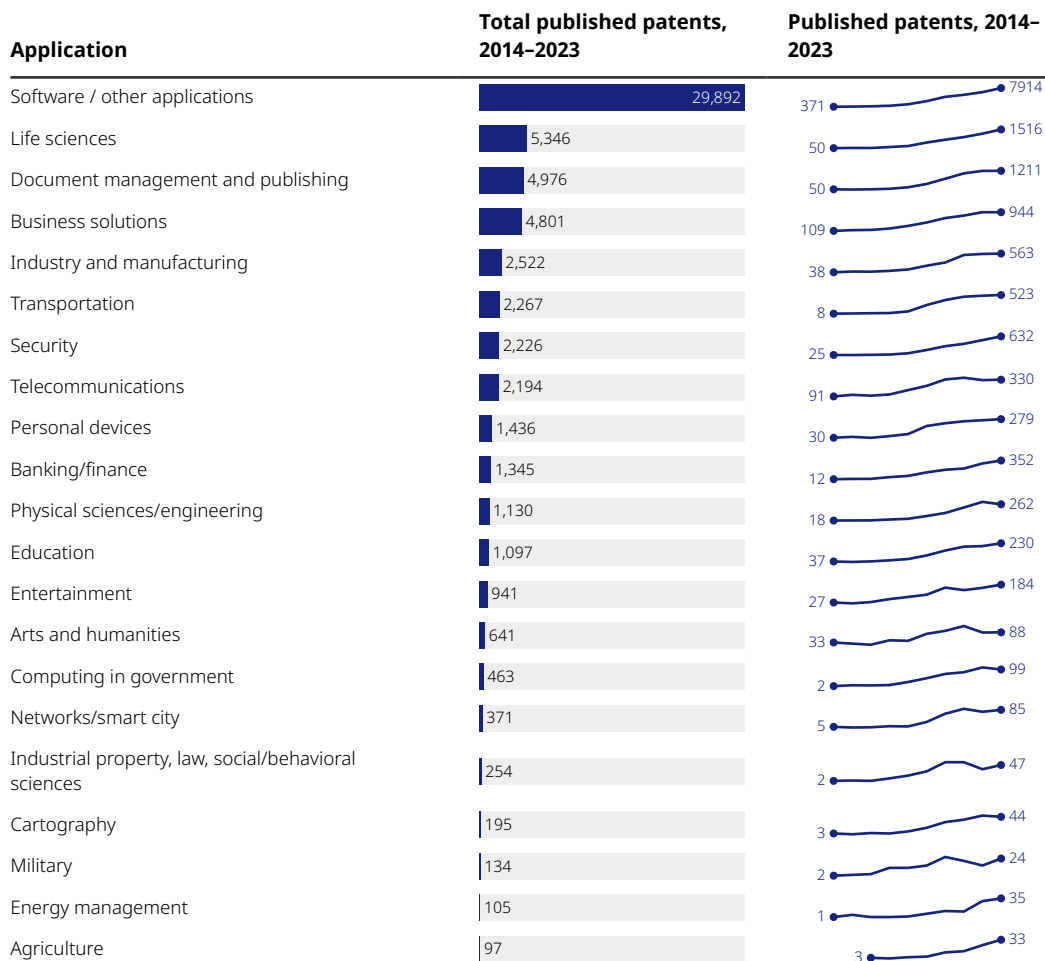

Source: WIPO, based on patent data from EconSight/IFI Claims, April 2024.

In general, patent growth has been high in all applications since 2014. However, over the last three years there have been diverging growth trends with very high growth rates in both smaller application areas such as agriculture and energy management and large fields such as life sciences, security and physical sciences/engineering. In contrast, the number of patent families has stagnated or even declined in certain application areas such as telecommunications, military, arts and humanities or industrial property/law/social and behavioral sciences (Figure 27).

Patents in the use of GenAI in energy management have seen the largest growth, both since 2018 and also in the last three years, with applications in agriculture also growing more in the last three years.

Figure 27 Average annual growth of patent families in GenAI applications

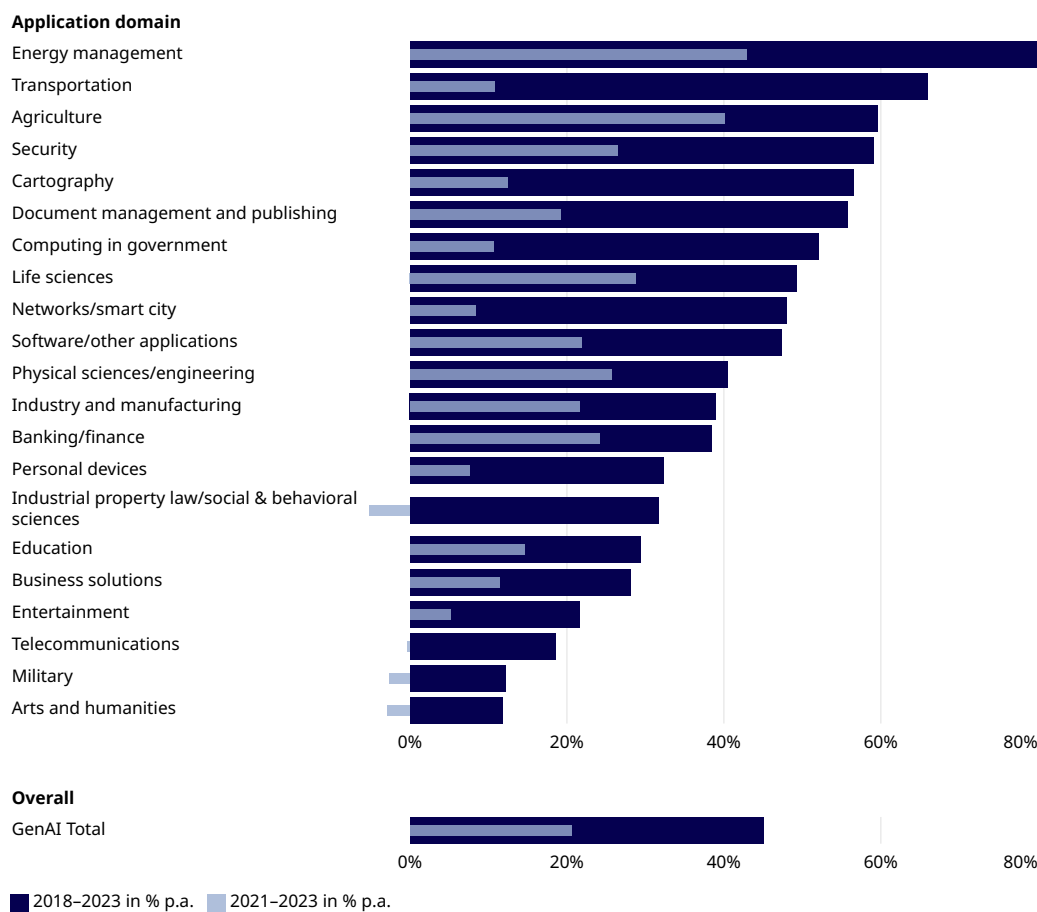

Source: WIPO, based on patent data from EconSight/IFI Claims, April 2024.

Top patent owners

Tencent is the top company in several GenAI applications. The social media/gaming company leads in software/other applications, document management and publishing, personal devices, entertainment, security and arts and humanities (Table 10).

Ping An Insurance Group ranks second overall. It has transformed itself from a traditional financial services company into a technology ecosystem with several technology subsidiaries in various industries. The company holds the top spot in the global ranking in business solutions, life and medical sciences, banking and finance, computing in government, industrial property/law/social and behavioral sciences, education and networks and smart cities.

Baidu is the leader in physical sciences and engineering and arts and humanities and also a key player in software and other applications, document management and publishing, and transportation.

IBM has a strong research position in various fields such as software/other applications, document management and publishing, business solutions as well as life and medical sciences.

Alibaba ranks fifth overall, with particularly strong research priorities in software/other applications, document management and publishing, business solutions and arts/humanities.

Although patent portfolios of the top owners are dominated by patents in software/other applications, document management and publishing is also an area where the top owners have filed patents.

Table 10 Top patent owners in GenAI applications (companies), 2014–2023

	Tencent (China)	Ping An Group (China)	Baidu (China)	IBM (US)	Alibaba (China)	Samsung Electr. (Republic of Korea)	Alphabet / Google (US)	Bytedance (China)	Microsoft (US)	BBK Electronics (China)
Software/other applications	1,363	875	789	347	324	259	306	308	224	300
Life and medical sciences	73	227	34	59	7	16	27	7	21	1
Document management and publishing	239	204	183	58	73	39	13	44	61	27
Business solutions	119	124	51	40	91	33	11	9	39	11
Industry and manufacturing	29	52	17	25	19	19	14	5	14	3
Transportation	68	17	42	29	8	18	26	5	6	3
Security	42	30	19	23	21	15	5	3	9	5
Telecommunications	27	25	34	9	21	46	29	7	12	9
Personal devices, computing and HCI	58	48	37	15	12	47	8	13	27	17
Banking and finance	9	101	11	6	6	0	0	0	0	0
Physical sciences and engineering	22	9	48	26	2	28	9	5	6	6
Education	14	20	12	16	6	12	7	6	7	0
Entertainment	90	2	4	9	5	5	4	5	12	4
Arts and humanities	15	12	15	3	10	12	3	4	8	4
Computing in government	7	15	10	4	0	2	1	0	3	1
Networks/smart cities	1	23	11	8	5	5	3	0	1	0
Industrial property law/social & behavioral sciences	1	17	2	0	4	0	0	0	0	0
Cartography	6	3	6	2	3	0	0	0	0	1
Military	7	5	0	2	1	1	1	0	1	0
Energy management	0	0	0	0	0	0	2	0	0	0
Agriculture	0	1	0	1	0	0	5	0	0	0

Source: WIPO, based on patent data from EconSight/IFI Claims, April 2024.

Samsung is ranked sixth overall, with a research focus on areas such as telecommunications (world leader in patents) and personal devices (third place)

Alphabet/Google's strengths in GenAI are in software/other applications, life and medical sciences, transportation and telecommunications. The company is also the world leader in GenAI in agriculture.

The majority of Bytedance's GenAI patents are in the fields of software/other applications and document management and publishing.

Microsoft has developed many GenAI patent families over the last decade in software/other applications, document management and publishing, business solutions and personal devices.

BBK Electronics has a clear research focus on software/other applications.

Other notable GenAI research companies outside the top 10 include:

- Huawei (China): the Chinese ICT company has a research focus on software/other applications, document management and publishing, business solutions, telecommunications and transportation.
- Adobe (US): the software company has many GenAI patent families in the areas of software/other applications and document management and publishing.
- Bosch (Germany): the world's biggest car supplier is a top GenAI research company in transportation.

- Netease (China): the Chinese gaming company is the world leader in GenAI patents in entertainment.
- Siemens (Germany): the German industrial conglomerate has developed the second most GenAI patents in life and medical sciences.
- Nvidia (US): the leading chipmaker for high-tech AI chips has many GenAI patents in the fields of software/other applications, entertainment and transportation.
- Sony Group (Japan): the Japanese conglomerate has the third most GenAI patents in entertainment.
- LG Electronics (Republic of Korea): the electronics conglomerate from the Republic of Korea is in second place in GenAI in both transportation and networks/smart cities.
- Bank of China (China): the large Chinese bank has many GenAI patents in banking/finance (second place).
- UiPath (US): the robotic process automation company has developed most GenAI patent families in industry and manufacturing and is also a research leader in business solutions.
- Hitachi (Japan): the Japanese conglomerate has the second most GenAI patent families in energy management.
- Autodesk (US): the software company is one of the top research players in GenAI in physical sciences and engineering as well as industry/manufacturing.
- State Grid (China): the world's largest utility is the world leader in GenAI patents in energy management and has also developed many GenAI patents in the areas of industry and manufacturing and security.

Among the top research organizations, the Chinese Academy of Sciences (CAS) stands out. It holds the largest number of GenAI patent families in many applications such as software/other applications, life/medical sciences and document management and publishing (Table 11).

The Chinese Tsinghua University has a strong position in software/other applications, life/medical sciences, document management and publishing, and transportation. It also ranks first among research organizations in industrial property/law/social and behavioral sciences.

The Chinese Zhejiang University has developed many GenAI patent families in software/other applications, document management and publishing, transportation and security.

The Zhejiang University of Technology from China is ranked fourth overall, excelling in fields as diverse as life and medical sciences, security, transportation and telecommunications.

The National Research Council of Science and Technology from the Republic of Korea has a research focus on GenAI in software/other applications.

The Chinese Academy of Sciences is the only research organization that has patent filings in all application domains except one.

Table 11 Top patent owners (universities/research organizations), 2014–2023

	Chinese Academy of Sciences	Tsinghua University	Zhejiang University	Zhejiang Univ. of Technology	National Research Council of Science and Technology	Nanjing Univ. of Aeronautics and Astronautics	Dalian Univ. of Technology	China Univ. of Petroleum	China Univ. of Mining and Technology	Univ. of California
Software/other applications	373	208	196	108	54	52	44	50	21	14
Life and medical sciences	101	29	34	20	2	5	9	5		13
Document management and publishing	58	29	28	6	5	4	7	1	3	2
Business solutions	10	8	9	1	6	1	2		2	1
Industry and manufacturing	11	9	10	9	2	2	3	5	3	
Transportation	20	14	19	15	7	8	9	6	6	1
Security	19	8	19	16	4	4	4	1		
Telecommunications	7	7	4	10	8	5	1			2
Personal devices, computing	5			1	2					1
Banking and finance	3	2	1	2						
Physical sciences and engineering	15	8	5	2	2		3	3		2
Education	4	1	2	1	5		1		1	1
Entertainment	1	1	1			1		1		3
Arts and humanities	7	3	4	1	1	1			1	
Computing in government	10	2	2	5		1	1	2		
Networks/smart cities	1	2		4						
Industrial property law/social & behavioral sciences	3	6	3							
Cartography	4			1		1				
Military	1	1	1							
Energy management		2	1							
Agriculture	1		2							

Note: Only GenAI applications included where the research organizations have developed at least one patent family.

Source: WIPO, based on patent data from EconSight/IFI Claims, April 2024.

Key locations of inventors

The category software/other applications is the dominant GenAI research field for all top inventor locations in terms of patent families between 2014 and 2023 (Table 12).

China is the leading inventor location for all GenAI applications. China's relative lead is particularly pronounced in fields such as software/other applications, document management and publishing, banking and finance, energy management, cartography and industrial property, legal, social and behavioral sciences.

The US is in second place and has a very high share of all GenAI patent families in physical sciences and engineering, life and medical sciences, military, agriculture, entertainment and education.

The Republic of Korea shows a relatively high number of GenAI patent families in business solutions, education and agriculture. In relative terms, Japan has a strong research position in entertainment, and arts and humanities. India has an above-average share of all GenAI patent families in networks and smart cities. The UK stands out in physical sciences and engineering. Germany is in a good research position in physical sciences and engineering and industry and manufacturing.

Apart from the biggest number of patents in software/other applications in all inventor locations, the next biggest application areas vary depending on inventor location.

Table 12 Patent families in GenAI applications in top inventor locations, 2014–2023

	China	US	Republic of Korea	Japan	India	UK	Germany
Software/other applications	22,236	2,746	1,803	2,056	376	352	318
Life and medical sciences	3,181	979	531	261	75	113	126
Document management and publishing	3,833	556	259	159	107	46	29
Business	2,882	697	718	318	108	40	27
Industry and manufacturing	1,438	462	306	131	76	64	88
Transportation	1,458	352	250	103	40	32	58
Security	1,488	341	172	66	45	51	41
Telecommunications	1,277	397	273	143	40	37	31
Personal devices, computing and HCI	866	229	158	108	42	6	15
Banking and finance	1,050	114	90	50	11	12	7
Physical sciences and engineering	525	354	125	44	33	51	39
Education	506	208	207	102	18	13	14
Entertainment	491	211	83	99	8	27	9
Arts and humanities	383	97	60	75	6	11	6
Computing in government	310	64	58	17	5	0	5
Networks/smart cities	245	58	46	3	16	3	2
Industrial property law/social & behavioral sciences	212	23	14	2	1	2	0
Cartography	147	25	9	3	5	0	3
Military	82	28	19	3	0	5	0
Energy management	79	9	10	2	0	2	3
Agriculture	48	21	14	9	2	3	2

Source: WIPO, based on patent data from EconSight/IFI Claims, Orbit by Questel and PATENTSCOPE, April 2024.

Connection between core models and applications

There is an interdependence between GenAI models and applications (Figure 28):

- GAN models play a dominant role in almost all GenAI applications, with the most pronounced relevance in transport. GAN models are particularly useful for generating images and videos. Therefore, these models play an important role in areas such as autonomous driving. For example, GAN models can be used to generate images or videos to train autonomous vehicles.
- VAEs are important for application areas such as physical sciences and engineering, networks/smart cities or personal devices. VAEs excel at capturing the underlying structure (latent space) of the data they are trained on. They can be used to generate new data such as images or to detect anomalies in data points. VAEs are a promising tool for various tasks in physical sciences and engineering, particularly in areas of data exploration or the discovery

of novel materials, molecules and designs. They can also contribute to the generation of digital twins.¹

- LLM models have a particularly high share in applications such as document management and publishing, business solutions, personal devices, education, entertainment or industrial property, law, social and behavioral sciences. LLMs excel at text-based tasks such as generating creative text formats which can be used for content generation, machine translation or chatbots. However, new multimodal LLMs are also able to process other data such as images, videos or code.
- Diffusion models excel at tasks requiring high-fidelity and controllable output generation. The patent data analysis shows a high share of diffusion models in computing in government, networks and smart cities, life and medical sciences and business solutions. For example, diffusion models can be used in the area of life and medical sciences to manipulate medical images while preserving key information or to generate realistic protein sequences and structures.
- Autoregressive models are applicable to various tasks in GenAI, particularly those that involve sequential data generation. They are particularly important in the field of banking and finance due to their strengths in sequential data analysis. This is useful for forecasting financial data such as stock prices, exchange rates, interest rates, etc., as well as for tasks such as fraud detection or credit risk assessment.

Each type of GenAI model is used for the various applications, however some models are particularly useful for certain applications, such as GANs for transportation or LLMs for document management and publishing.

Figure 28 Interdependence between GenAI models and the largest GenAI applications, 2014–2023

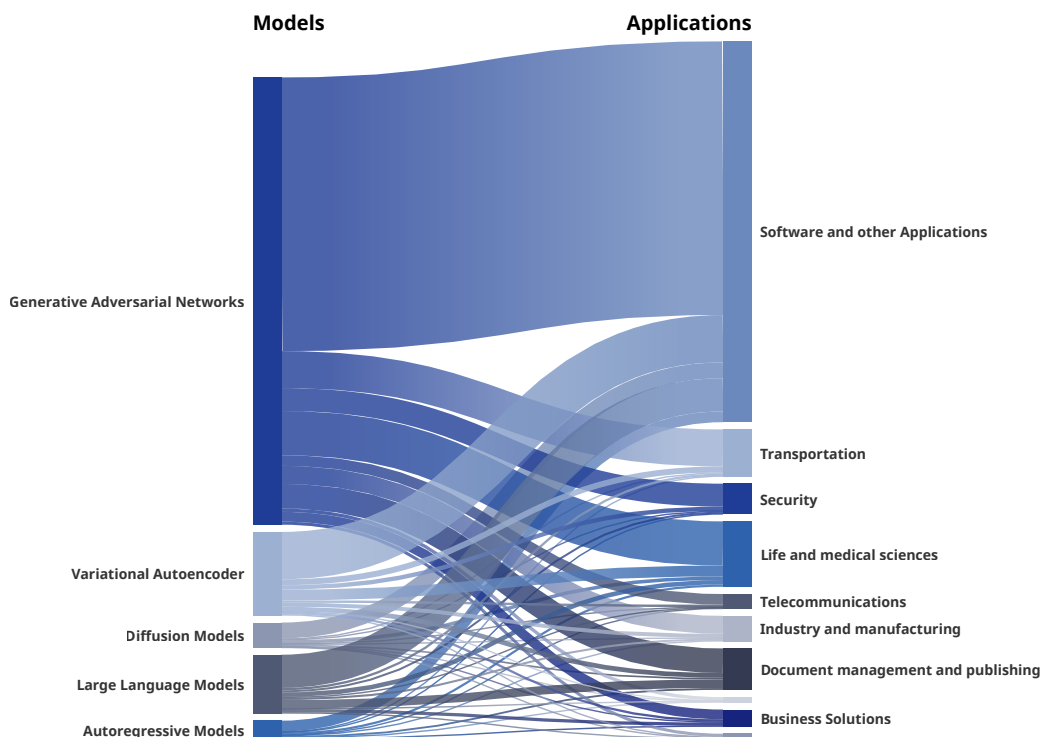

Note: Only the ten largest GenAI applications in terms of patent families are shown. Only GenAI patent families are included that are assigned to the five core GenAI models. A table with the specific numbers for the connections between GenAI models and all applications is included in Appendix A.3.

Source: WIPO, based on patent data from EconSight/IFI Claims, April 2024.

1 A digital twin is a virtual replica of a physical object or system. It is a computer-generated counterpart that mirrors the real world in real time, allowing you to monitor its performance, predict issues and optimize its operation.

Connection between modes and applications

Regarding the use of GenAI modes in GenAI applications, we can see the following results (Figure 29):

- Image, video is the dominant data type for GenAI in software and other applications. It is also a very important GenAI data source for transportation, life and medical sciences, arts and humanities, agriculture and cartography.
- Text data plays a major role for GenAI patents in software and other applications, document management and publishing, arts/humanities, industrial property law/social and behavioral sciences.
- Speech/voice/music is the most important data type in personal devices, telecommunications, personal devices and education and also relevant for software and other applications.
- Molecules/genes/proteins data is mainly used for GenAI in life and medical sciences as well as physical sciences and engineering.
- Software and code plays an important role for GenAI patent families in security and banking/finance.
- Other modes are an important source of data for GenAI in software/other applications, banking and finance, business solutions and industry/manufacturing.

The GenAI modes used for each application depend on how data is processed and the output required for the particular application, with almost all modes used to some extent for all applications.

Figure 29 Interdependence between the largest GenAI applications and GenAI modes, 2014–2023

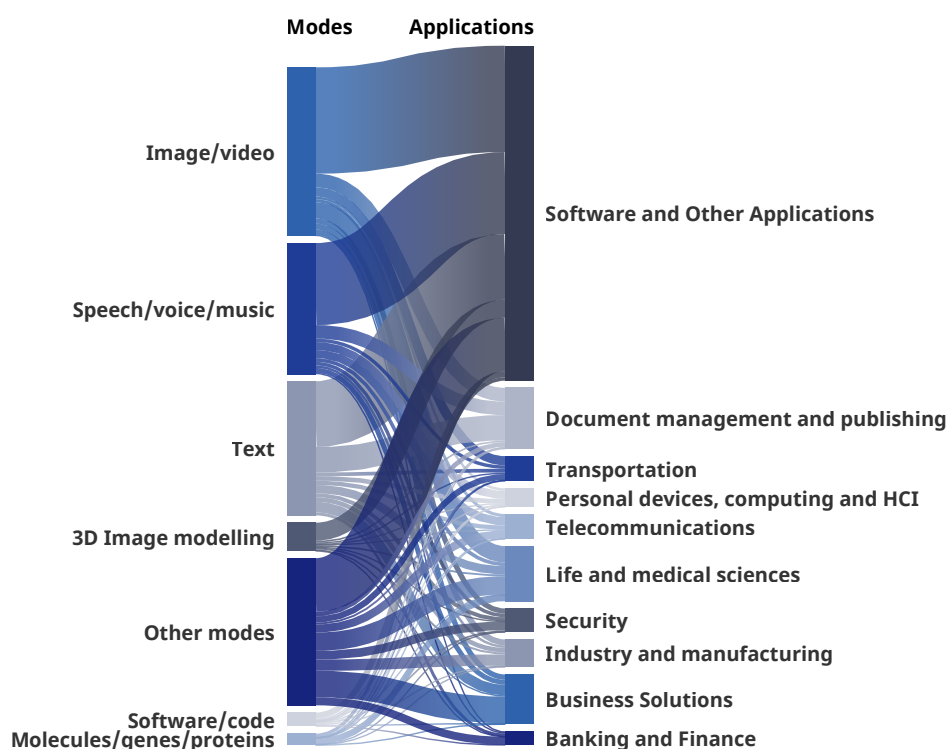

Note: Only the ten largest GenAI applications in terms of patent families are shown. A table with the specific numbers for the connections between GenAI modes and all applications is included in Appendix A.3.

Source: WIPO, based on patent data from EconSight/IFI Claims, April 2024.

6 Further considerations

The emergence of GenAI will have a significant impact on various industries, providing companies, organizations and individuals with unprecedented capabilities to create, synthesize and manipulate data. However, there are also concerns about the increasing use of GenAI models and tools, ranging from copyright infringement and the potential for misuse, to the risk of job displacement.

Concerns about the use of GenAI

The emergence of GenAI will have a significant impact on various industries, providing companies, organizations and individuals with unprecedented capabilities to create, synthesize and manipulate data. However, there are also concerns about the increasing use of GenAI models and tools, ranging from copyright infringement and the potential for misuse, to the risk of job displacement.

The impact of GenAI on the labor market

In terms of the impact on employment, a common fear is that GenAI will lead to significant job losses in many industries as machines become capable of performing tasks previously done by humans. A recent study by Goldman Sachs predicts that GenAI will significantly disrupt the labor market, with around 300 million workers in major global economies exposed to some degree of GenAI automation (Financial Times 2023). However, the impact will vary significantly from job to job. In fact, many professions will benefit from GenAI tools that complement their work and enhance their capabilities, allowing professionals to focus on higher-level, more strategic aspects of their work. As a result, GenAI, like other forms of automation before it, should boost GDP growth and improve overall income levels, particularly for countries. However, some jobs are certainly at risk of becoming obsolete, and AI-sensitive individuals will need targeted support to transition to new opportunities and retrain for emerging roles. Moreover, unlike previous waves of automation, which mainly affected middle-skilled workers, the risks of AI displacement extend to certain higher-paid positions such as certain types of data analysts, market research analysts, bookkeepers or paralegals.

The role of GenAI regarding copyright and the protection of intellectual property

Concerns have also been raised about potential copyright infringement of GenAI art, text and code, as well as training data. AI models may generate text, images and audio that closely resemble existing works, potentially infringing copyright. As a result, copyright issues are already fueling debate in a number of jurisdictions. In the US, for example, artists, writers and others have filed lawsuits accusing major AI companies such as OpenAI of using their copyrighted work to train AI systems without permission (Brittain 2023). Another much debated issue is the question whether AI inventions can be patented, as AI models and tools play an increasingly important role in innovation activities. For example, a recent decision by the US Federal Circuit stated that inventions developed purely by an AI machine are not patentable, whereas inventions made by humans with the assistance of AI are (Nemec and Rann 2023).

The examples above are non-exhaustive, and full consideration of the various legal issues surrounding IP and GenAI are beyond the scope of this study.¹

Other concerns include deepfakes and training biases

Other areas of concern include deepfakes, which are fake images or videos that insert a person's likeness into another video without their consent. Because GenAI can create highly realistic and convincing content, these deepfakes can be used for malicious purposes, such as spreading misinformation during election campaigns.

In addition, while the capabilities of GenAI models have improved significantly in recent years, these models still sometimes produce incorrect results. For example, answers from chatbots may sound convincing but may be wrong (e.g. AI hallucination)² or biased due to distortions in the training datasets. GenAI, and AI in general, is only as good as the data it is trained on, and existing biases in the training data will lead to biases in the results. Therefore, it is important that humans remain involved in decision-making, especially in industries where trust is paramount, such as finance or healthcare (Baxter and Schlesinger 2023).

Will GenAI evolve into a general AI?

Although the latest GenAI models use human-like language and appear creative and intelligent in their output, they are still far away from human intelligence, as GenAI models do not really understand things but instead are still only capable of making very good guesses based on their input data. Whether GenAI models can be further improved to have the ability to reason is the subject of much debate. Some AI advocates believe that GenAI is an essential step towards general AI and even consciousness. There are concerns that progress in the development of GenAI requires a sense of urgency to ensure that humanity can still contain and manage these models. Some experts have even called for a pause in AI development (Narayan et al. 2023). Others argue that even faster advances in AI would provide tools to better understand the technology and make it safer. One example is OpenAI's use of reinforcement learning from human feedback (RLHF) to create guardrails that make ChatGPT's responses more accurate and appropriate (Goldman Sachs 2023). It is also important to note that there is significant disagreement among experts about when general AI will be achieved, with many experts believing that general AI is still a long way off (World Economic Forum 2023).

Regulations are being developed to address these concerns

In light of the above concerns about GenAI, new GenAI regulations are being developed and introduced around the world with the aim of harnessing the benefits of GenAI while mitigating the risks. The goals of regulation vary from country to country, but typically include protecting consumers, preventing misuse and ensuring responsible development.

China was one of the first countries to introduce legislation on GenAI, just months after ChatGPT was launched (Yang 2024). The country initially focused on individual pieces of legislation for different types of AI products. As a result, in 2023 China had different rules for algorithmic recommendation services than for deepfakes or GenAI. However, in January 2024, China's Ministry of Industry issued draft guidelines for standardization of the artificial intelligence (AI) industry, with more than 50 national and industry-wide standards for AI to be formed by 2026 (Ye 2024).

The EU has also been working on regulating AI. In March 2024, the EU Council and Parliament adopted the EU AI Act, which is expected to come into force in another month or two. The AI Act will regulate providers of artificial intelligence systems by categorizing the type of applications into different risk categories, including a category for a potential future general AI. Companies developing GenAI models and tools that are deemed to pose a "high risk" to fundamental rights, such as those intended for use in sectors such as education, healthcare and policing, will have to

1 For a more detailed discussion of IP risks regarding the use of GenAI and potential mitigations see the latest WIPO guidelines on GenAI (WIPO 2024a) and the WIPO Economic Research Working Paper on AI and IP (WIPO 2024b).
2 AI hallucination is a phenomenon whereby a GenAI tool generates facts in a coherent and grammatically correct but nonsensical, inaccurate manner, resulting in misleading information.

meet new EU standards. The law will require companies to be more transparent about how their models are trained, and to disclose any copyrighted material they use for training. It will also ensure that AI systems deemed high risk are trained and tested using sufficiently representative datasets, for example to minimize bias. Other uses of AI will be banned outright in the EU, such as the creation of facial recognition databases or the use of emotion recognition technology in the workplace or schools.

The US has not regulated GenAI so far, but there have also been certain steps, for example by the Federal Trade Commission (FTC). In addition, the Biden administration issued an executive order in October 2023 directing federal agencies to develop a comprehensive national strategy for regulating artificial intelligence with GenAI as a specific area of concern. The focus in the US is on creating best practices with a reliance on different agencies to craft their own rules.

Responsible AI best practices and approaches can also help

Another approach to addressing concerns about GenAI and AI in general is the development of so-called Responsible AI. Responsible AI is an umbrella term for making appropriate and ethical decisions related to AI. It includes best practices and responsibilities for companies and other organizations to ensure the responsible and ethical development and use of AI. Some steps to achieve this include (Gillis 2023):

- Transparency and explanations: there should be documentation of the training data used and the algorithms employed to avoid potential copyright infringement and to allow users to understand how the GenAI models work. Users should also be educated about the risks and benefits of GenAI.
- Mechanisms (for example regulatory frameworks) should be put in place to hold developers and users accountable for the ethical use of GenAI.
- Avoid bias: responsible AI must ensure that biases are identified and addressed so that GenAI algorithms do not unfairly discriminate against certain groups of people.
- Human-in-the-loop approach: GenAI models should be integrated by companies with human oversight and judgment.
- Monitoring: ongoing monitoring of GenAI models and tools ensures that real-world performance and user feedback are taken into account to address potential issues.
- Resilience: GenAI and AI systems in general should be resilient to potential threats such as adversarial attacks.

Limitations and future of patent analysis in relation to GenAI

Methods of patent analysis are changing

Patent analysis is an established field and has been widely used for years, and while tools have become more powerful, the methodology has not changed dramatically. Analysts use patent classes and keywords to build searches and count, measure and visualize the results.

However, the world of patent search and analysis may see its biggest changes in the coming years, and the patent landscape for GenAI shows perfectly why. Patent classes are built after a concept has reached a certain popularity, keywords are sharpened and defined only after they appear for the first time. While it has always been difficult to do traditional patent analysis on emerging topics, it is now closer to being impossible to get an accurate collection of patents using traditional tools. Digital fields now follow different laws of development compared to classical technical advancements. New concepts or technological improvements can spread rapidly due to the extensive reach of global networks. GenAI, such as ChatGPT, is an example of this. Within just five days, the tool had a million users, while streaming services like Netflix took 3.5 years to reach the same number of users. Even before the patent system can respond in the form of new patent classification classes/subclasses, groups etc. or well-defined keywords, technology development has already advanced several steps further. At the same time, generic or descriptive terminology is used that is either nonspecific or semantically ambiguous. GenAI also exemplifies this issue: there is a semantic difference between saying "an image generated by AI" (from data that did not previously exist) and "AI was used in the image generation process" (as in image classification or in object detection etc.).

It was already useful to use AI for the WIPO Technology Trends Report on AI (WIPO 2019), but it is even more relevant to use modern classification tools and advanced LLMs today to create an accurate patent collection for GenAI, as done in this report. We have already seen the introduction of patent-trained LLMs, e.g. from Google with BERT for Patents (Google 2020), from EPO for automatic classification (EPO 2023) and for patent search with Searchformer (Vowinckel and Hähnke 2023) or from academia (Freunek and Bodmer 2021).

However, the impact of GenAI on how people will generate text, visuals, insights, statistics and even new innovations using GenAI tools has the potential to turn the patent analytics space, like many others, upside down. Instead of using patent classes that first need to be discussed, created and agreed, it will be possible to ask GenAI tools to show areas of development or to collect the appropriate patents for new cutting-edge concepts directly on a prompt or with fine-tuned models. The patent analysis of GenAI, that we have conducted in this report, should therefore be understood as an approach using the most advanced methods and tools available at the time of the analysis. It is to be expected that these tools will develop faster than the traditional patent information system, and will therefore be able to challenge old patent analysis methods very soon.

We are only seeing the beginning of the GenAI patent wave

Collecting the patents for GenAI has been a challenge, but the growth is clearly visible and measurable. In contrast to scientific publications, we have, however, very limited visibility on recent patent trends as patents are only published 18 months after their filing in most jurisdictions. It is likely that most current patent applications in GenAI have not yet been published. We can expect a wave of related patents very soon, especially as the success of ChatGPT has driven innovation in a wide range of applications. We can only guess at what is to come by counting the patents from patent offices that publish earlier than 18 months on average, such as China. A future update study at a later date should be able to visualize this development, perhaps by using GenAI itself to do the work.

Appendices

Find out more about the methodology used, the approach to searching GenAI patents using traditional patent search techniques alongside new AI search tools, and explore example patents for different GenAI application areas.

A.1 Methodology for patent analysis

Patent identification and mapping to a definition

Transforming a technology definition into a patent data collection is one of the crucial steps in laying the foundation for a patent analysis. The most relevant aspect of a patent analysis is therefore the method of finding patents that fit the definition. Guidelines, such as those provided by WIPO (2015), can generally be followed with relevant keywords collected as well as patent classes and search concepts built that gather the patents to a definition within an optimal relation of precision and recall.

GenAI, however, is a modern concept without clear technical definition and where patent classes are not fully established yet. The most relevant patent classifications for GenAI are found in the Co-operative Classification Scheme¹ (CPC) G06N3/045 (“Auto-encoder networks; Encoder-decoder networks”), a sub-group of G06N3/02 Neural Networks.² Most of the sub-groups in this area were newly introduced in 2023 and publications are currently being reclassified. There is not a proper class for GenAI itself yet.

GenAI can be viewed as a generic concept corresponding to the application of specific software methods to a large number of datasets (“modes”), addressing multiple applications. This is reflected in the use of many generic terms in patents today, often without defining the underlying technology used whose implementation is left to general knowledge of the skilled person in the art.

We had to develop a specific approach for capturing patents, involving the generation of digital entities, such as images, text or data through the use of specific machine learning algorithms. To achieve this, we used a two-stage approach: first, we combined classical patent searches together with prompts using our AI tool (see Appendices A.4 and A.5 for the patent searches and prompts) to retrieve a first patent dataset with high recall. Second, we refined the previous set using a trained BERT classifier to increase precision. This approach helps to avoid patents that are not “GenAI” according to the usually accepted definition, but that might generate products or other things (such as 3D printers or cameras) by using AI techniques somewhere in a process.

1 <https://www.epo.org/en/searching-for-patents/helpful-resources/first-time-here/classification/cpc>
2 <https://worldwide.espacenet.com/patent/cpc-browser#!/CPC=G06N3/045>

BERT

BERT (Bidirectional Encoder Representations from Transformers) is a large language model (LLM) developed by Google, is built on the Transformer architecture, and was introduced in 2018 (Devlin et al. 2018). In contrast to modern LLMs that only retain the decoder part of the original transformer architecture, BERT only keeps the encoder part to address discriminative tasks. BERT is pretrained on large amounts of text data. The training involves two main processes: 1. Masked language modeling, and 2. Next sentence prediction.

In masked language modeling, words in the input text are randomly selected and replaced with a special [MASK] token. The model is then trained to predict the original words based on the context provided by the surrounding words. This helps learning the bidirectional context of words in a sentence.

In next sentence prediction, the model is trained to predict for pairs of sentences whether the second sentence in a pair follows the first sentence. This task helps capturing relationships between sentences and understanding the overall context of the text input.

In order to use BERT in practical applications, it is fine-tuned to the specific task with labeled data in a supervised manner. BERT has proven to be highly effective and is utilized in various natural language processing tasks, including text classification, entity recognition, sentiment analysis and more.

There are different variants of BERT available, such as BERT Base, BERT Large, cased, uncased and there are models that are based on BERT but differ from it in terms of parameters, training methods, languages, such as RoBERTa, DistilBERT, XLM-RoBERTa etc. In this study, we use the BERT base uncased model with 110M parameters.

Sentence BERT

Sentence-BERT (SBERT) is a modification of the BERT model and is specifically designed for the calculation of text representations (text embeddings or text vectors).

The key idea behind SBERT is to fine-tune BERT on datasets that are crafted for sentence-level tasks. The model learns to produce embeddings that capture semantic information about sentences. Text similarities can be calculated based on calculations of the cosine-similarity of the embeddings. There is a maximum context length, which is typically about 512 tokens, so SBERT is not restricted to sentences in the literal sense. There are different types of SBERT models with varying performance in semantic search, encoding speed and model size.

Patent searches/prompts

To gather the basic dataset we have used three approaches:³

- Method 1a: A patent search using generic terms such as “generative AI” to locate patents using specific keyword concepts only. These concepts are searched more broadly or narrowly in different patent classifications.
- Method 1b: Five patent searches for the specific search concepts: Generative Adversarial Networks (GAN), Autoregressive Models, Diffusion Models, LLMs and Variational Autoencoders. These five concepts are considered as almost a synonym to the concept “generative AI.”
- Method 2: About one hundred prompts for various concepts of GenAI and its use, by using EconSight’s advanced AI search algorithms.

3 The patent search definitions and prompts are listed in Appendix A.4.

Patent classification

The fused datasets from the above searches are then transferred to a BERT classifier to increase accuracy and to identify patents that are really “generative AI.” This BERT is fine-tuned on this technology field as a classifier and is then used to classify the patents according to the technology field into two classes:

- Class 1: patent is GenAI
- Class 2: patent is not GenAI

To achieve the BERT fine-tuning, we identified a training dataset of patents that can be assigned to GenAI (seed patents, label 1) and patents that cannot be assigned to GenAI (negative-seed patents, label 2). While the seed patents cover the whole range of GenAI topics, the negative seeds are a mixture of patents that are thematically very close to GenAI, but not exactly related to it. This means the selection of AI/machine learning patents that are not GenAI. A sample-based test of the accuracy of the BERT classifier delivers the following values: precision = 0.8, recall = 0.9, F1 score = 0.85.

Data collection, patent counting

- Simple patent families are counted as a proxy for individual inventions in the report. A simple patent family is a set of patents in various countries in relation to a single invention. The technical content covered is considered to be identical. All patent documents have the same priority date or combination of priority dates. The first publication by a member of a patent family counts as the publication year.
- Most analysis in the report refers to numbers of patent families.
- Patent families generally include only patents and not utility models, without assessing their legal status.
- Active patent portfolios: for this type of analysis, only active patent families (as in the INPADOC legal status definition) are counted. Active patent families are time-specific (active in a certain year) and highly relevant when analyzing a company’s patent strength.
- The origin of the inventor (inventor’s location or residence) is used as a proxy for the source of innovations. For patents with multiple inventors, we count the different locations listed and count the location for multiple inventors of the same origin once.

A.2 Patent indicators

Patent applicant/owner

Patents are filed by an applicant, which can be an organization or a natural person. Applicants are not inventors, even if sometimes they are similar. The applicant is in most jurisdictions and in most cases published with the patent and remains always the applicant. The applicant is not automatically the owner of a patent at a given time, even if that is often the case. Patents can be transferred or sold, or the applicant itself can be sold as a company in a merger or takeover. Therefore the “owner” of a patent might change over time and it is not always published. For proper analysis, to consolidate incorrect spelling and to include merger and acquisition information in the analysis, the report used the ultimate owner concept in the IFI Claims global patent database. The most probable entity was then named as owner.

Patent family

A patent family is a collection of patent applications covering the same or similar technical content and all sharing one or more priority documents. Families are used to count inventions and not several patents corresponding to the same subject matter and filed in different jurisdictions. There are several definitions of patent families, including simple and extended patent families (EPO, n.d.; WIPO, 2015), depending on the number of priority documents shared (ranging from one to all priority documents). Patent family members are the individual patents filed in those jurisdictions where a patent applicant is seeking patent protection (e.g., WIPO, EPO) and all publications in relation to these (patent publications with code types A1, A2, B1 and

so on). In the present study, we counted simple patent families (using a representative patent family member for each patent family), unless otherwise specified.

Inventor country

The origin of the inventor (inventor's location or residence) is used as a proxy for the source of innovation. For patents with multiple inventors, we count the different locations listed and count the location for multiple inventors of the same origin once. If no inventor address is available, the patent priority country is used as a proxy for the source of innovation.

Filing country

Jurisdiction in which a member of a patent family has filed a patent application to seek patent protection.

A.3 Interdependence between models, modes and applications

Table A1 Interdependence between GenAI modes and GenAI models, 2014–2023

	GAN	LLM	VAE	Diffusion models	Autoregressive models	GenAI Total
Image/video	6,802	196	658	363	83	17,996
Text	782	850	245	65	142	13,494
Speech/voice/music	323	267	163	38	92	13,480
3D image models	618	38	72	49	11	3
Molecules/genes/proteins	129	20	147	20	17	1,494
Software/code	176	47	30	6	10	1,340
Other modes	2,281	151	727	121	106	14,270

Note: A large proportion of all GenAI patent families do not fit into any of the five specific core models, as these patents do not contain keywords relating to the specific model used in the patent abstract, claims or title. Hence, the total number of GenAI patent families is much larger than the sum of the five core GenAI models. Patent families can be assigned to more than one mode and/or model.

Source: WIPO, based on patent data from EconSight/IFI Claims, April 2024.

Table A2 Interdependence between GenAI applications and GenAI models, 2014–2023

	GAN	LLMs	VAE	Diffusion models	Autoregressive models	GenAI Total
Software/other applications	6,112	742	1,057	353	241	28,892
Life and medical sciences	988	102	242	79	50	5,346
Document management and publishing	550	191	106	38	42	4,976
Business solutions	217	73	52	20	17	4,801
Industry and manufacturing	403	47	89	13	15	2,528
Transportation	826	52	133	26	14	2,267
Security	512	46	97	16	10	2,226
Telecommunications	238	22	54	4	8	2,194
Personal devices, computing and HCI	69	25	21	3	4	1,436
Banking and finance	75	12	12	5	13	1,345
Physical sciences and engineering	166	9	97	9	5	1
Education	87	29	18	2	5	1,097
Entertainment	53	18	13	1	2	941
Arts and humanities	105	10	8	6	5	641
Computing in government	76	8	18	9	2	463
Networks/smart cities	63	6	17	7	1	371
Industrial property law/social & behavioral sciences	6	8	2	1	0	254
Cartography	43	3	11	2	0	195
Military	33	3	3	0	0	134
Energy management	45	0	5	1	2	105
Agriculture	27	1	5	2	0	97

Note: Patent families can be assigned to more than one mode and/or application. A large proportion of all GenAI patent families do not fit into any of the five specific core models, as these patents do not contain keywords relating to the specific model used in the patent abstract, claims or title. Hence, the total number of GenAI patent families is much larger than the sum of the five core GenAI models. Patent families can be assigned to more than one mode and/or model.

Source: WIPO, based on patent data from EconSight/IFI Claims, April 2024.

Table A3 Interdependence between GenAI applications and GenAI modes, 2014–2023

	Image/ video	Text	Speech/ voice/ music	3D image models	Molecules/ genes/ proteins	Software/ code	Other modes
Software/other applications	11,475	7,089	8,851	1,945	367	662	5,754
Life sciences	1,754	896	395	196	685	43	1,979
Document management and publishing	1,480	2,741	1,460	178	51	174	506
Business	577	1,132	539	138	15	115	2,870
Transportation	637	495	270	219	56	104	1,220
Industry and manufacturing	996	403	370	157	47	53	670
Security	567	431	382	50	11	189	933
Telecommunications	336	464	888	78	8	41	875
Personal devices, computing and HCI	273	498	862	85	5	60	210
Physical sciences and engineering	90	329	122	15	0	52	857
Banking and finance	247	108	95	127	620	17	190
Education	243	325	409	84	6	15	384
Entertainment	250	107	197	143	0	39	458
Computing in government	260	268	217	87	2	16	102
Arts and humanities	106	127	81	19	12	6	195
Networks/smart cities	79	78	106	21	3	10	162
Energy management	21	171	29	2	1	5	70
Cartography	81	30	16	37	3	4	84
Industrial property law/ social & behavioral sciences	37	36	21	8	0	1	54
Agriculture	13	6	13	1	0	1	73
Military	38	11	11	8	9	3	36

Note: Patent families can be assigned to more than one mode and/or application.

Source: WIPO, based on patent data from EconSight/IFI Claims, April 2024.

A.4 Patent searches

GenAI models:

Generative AI total

```
(TITLEABSTRACTCLAIMS=(GENERATIVE* NEAR3 (AI OR ARTIFICIAL INTEL* OR ADVERSARIAL)
OR GENERATIVE SEQ2 PRE_TRAINED NEAR3 (LANGUAGE SEQ2 MODEL OR TRANSFORMER?)
OR CHAT_GPT OR VARIATIONAL SEQ2 AUTOENCODER? OR GENERATIVE SEQ2 ADVERSARIAL
SEQ2 NETWORK* OR DIFFUSION SEQ2 PROBABILISTIC SEQ2 MODEL? OR AUTO_REGRESSIV*
SEQ2 MODEL* ) OR (( IPC=(G06F 18/214, G06F 40/20, G06F 40/284, G06F 40/40, G06N 3/02,
G06N 3/08, G06N 20/00, G06Q 10/04, G06V 10/70, G10L 13, G16H 30/40, H04L 51/02) OR
TAG=("ECONSIGHT TECHNOLOGY FIELDS\IC5.3.9. NEURAL NETWORKS & DEEP LEARNING")
OR CPC=(G06F 18/214, G06F 40/20, G06F 40/284, G06F 40/40, G06N 3/02, G06N 3/08, G06N
20/00, G06Q 10/04, G06T2207/20, G06V 10/70, G10L 13, G16H 30/40, H04L 51/02) ) AND ( TITL
EABSTRACTCLAIMS=(GENERATIVE* NEAR3 (AI OR ARTIFICIAL INTEL* OR ADVERSARIAL) OR
GENERATIVE SEQ2 PRE_TRAINED NEAR3 (LANGUAGE SEQ2 MODEL OR TRANSFORMER?) OR
CHATGPT OR VARIATIONAL SEQ2 AUTOENCODER? OR CONVOLUTIONAL SEQ2 GENERATIVE
SEQ2 ADVERSARIAL SEQ2 NETWORK* OR DIFFUSION SEQ2 PROBALISTIC* SEQ2 MODEL? OR
DIFFUSIONAL SEQ2 NETWORK? OR DENOISING SEQ2 DIFFUSION SEQ2 PROBABILISTIC SEQ2
MODEL? OR GENERATIVE SEQ2 LATENT SEQ2 OPTIMIZATION OR NEURAL SEQ2 RADIANCE
SEQ2 FIELD? OR AUTO_REGRESSIV* NEAR3 MODEL* OR GAN OR GANS OR GENAI OR VAE OR
VAES OR (DENOISING OR VIDEO OR MODELS OR STABLE) NEAR3 DIFFUSION* SEQ2 MODEL* OR
VARIATIONAL NEAR3 AUTOENCODER* OR GPT_3* OR GPT_4* ) OR ( TITLEABSTRACTCLAIMS=(
((IMAGE* OR TEXT* OR VIDEO* OR SPEECH* OR ("3D" MODEL*) OR GENE SEQ* OR DESIGN OR
(PROGRAM* OR COMPUTER* OR SOFTWARE*) SEQ2 CODE* OR MUSIC* OR SPEECH* OR SCENE*
OR MOLECULE* OR SYNTHETIC SEQ2 DATA* OR WORD SEQ3 SEQUENC*) NEAR5 (GENERATE*
OR GENERATING* OR GENERATION* OR GENERATIV*)) OR GENERATIVE* NEAR3 MODEL*) AND
( TITLEABSTRACTCLAIMS=((TRANSFORMER* OR AUTOENCODER* OR LLM OR LARGE SEQ2
LANGUAGE SEQ2 MODEL* OR GAN OR GENERAT* SEQ2 ADVERSARIAL SEQ2 NETWORK* OR
(AUTO_REGRESSIV* OR DIFFUSION SEQ2 PROBALISTIC) SEQ2 MODEL*)) OR TAG=("ECONSIGHT
TECHNOLOGY FIELDS\IC5.3.23. GAN, GENERATIVE ADVERSARIAL NETWORKS", "ECONSIGHT
TECHNOLOGY FIELDS\IC5.3.27. AUTOREGRESSIV MODELS", "ECONSIGHT TECHNOLOGY
FIELDS\IC5.3.28. VARIATIONAL AUTOENCODER,VAE", "ECONSIGHT TECHNOLOGY FIELDS\
IC5.3.29. DIFFUSION MODELS", "ECONSIGHT TECHNOLOGY FIELDS\IC5.3.36. LARGE LANGUAGE
MODELS,LLM" ) ) ) ) ) OR ( IPC=(G06N 3/0475) OR CPC=(G06N 3/0475) )
```

Generative adversarial networks

```
(TITLEABSTRACTCLAIMS=(GENERATIVE NEAR5 ADVERSARIAL OR GAN OR (GENERATIVE SEQ2
ADVERSARIAL SEQ2 NETWORK*) OR (DUELING OR CONTRARIAN* OR ANTAGONISTIC OR
ADVERSARIAL) NEAR3 (NEURAL SEQ2 NETWORK*)) ) AND ( FTERMSMART=(5L096/HA11) OR
IPC=(G06N 3/02, G06V 10/70) OR CPC=(G06N 3/02, G06T2207, G06V 10/70) )
```

Variational autoencoder

```
(CPC=(G06F 40/20, G06F 40/284, G06F 40/40, G06N 3/02, G06N 3/08, G06N 20/00, G06Q 10/04)
OR IPC=(G06F 40/20, G06F 40/284, G06F 40/40, G06N 3/02, G06N 3/08, G06N 20/00, G06Q 10/04)
OR TAG=("ECONSIGHT TECHNOLOGY FIELDS\IC5.3.9. NEURAL NETWORKS & DEEP LEARNING" ) )
AND TITLEABSTRACTCLAIMS=(VARIATIONAL NEAR5 AUTO_ENCODER* OR VAE )
```

Autoregressive models

```
(CPC=(G06F 40/20, G06F 40/284, G06F 40/40, G06N 3/02, G06N 3/08, G06N 20/00, G06Q 10/04)
OR IPC=(G06F 40/20, G06F 40/284, G06F 40/40, G06N 3/02, G06N 3/08, G06N 20/00, G06Q
10/04) OR TAG=("ECONSIGHT TECHNOLOGY FIELDS\IC5.3.9. NEURAL NETWORKS & DEEP
LEARNING" ) ) AND TITLEABSTRACTCLAIMS=((((AUTO_REGRESSIV* OR AUTO_REGRESSION
OR SELF_REGRESSIV* OR SELF_REGRESSION* OR RECURSIVE_REGRESSION* OR ITERATIVE
FORECASTING) NEAR3 MODEL*))
```

Large language models

(CPC=(G06F 40/20, G06F 40/284, G06F 40/40, G06N 3/02, G06N 3/08, G06N 20/00, G06Q 10/04, G10L 15/183) OR IPC=(G06F 40/20, G06F 40/284, G06F 40/40, G06N 3/02, G06N 3/08, G06N 20/00, G06Q 10/04, G10L 15/183) OR TAG=("ECONSIGTH TECHNOLOGY FIELDS\EC\IC\IC5.3.9. NEURAL NETWORKS & DEEP LEARNING") AND TITLEABSTRACTCLAIMSDESCRIPTION=(LARGE SEQ2 LANGUAGE SEQ2 MODEL* OR LLM OR LARGE LANGUAGE MODEL* OR (LARGE LANGUAGE MODEL* OR LLM OR LARGE NEAR3 (LANGUAGE SEQ2 MODEL*) OR ((EXTENSIVE* OR MASSIVE OR LARGE OR GIGANTIC OR IMMENSE OR COLLOSSAL) SEQ2 (LANGUAGE OR LINGUISTIC OR SPEECH OR VERBAL) SEQ2 (MODEL*)) OR SUBSTANTIAL LANGUAGE PROCESSOR*))

Diffusion models

(CPC=(G06F 40/20, G06F 40/284, G06F 40/40, G06N 3/02, G06N 3/08, G06N 20/00, G06Q 10/04) OR IPC=(G06F 40/20, G06F 40/284, G06F 40/40, G06N 3/02, G06N 3/08, G06N 20/00, G06Q 10/04) OR TAG=("ECONSIGTH TECHNOLOGY FIELDS\IC5.3.9. NEURAL NETWORKS & DEEP LEARNING") AND TITLEABSTRACTCLAIMS=(DIFFUSION NEAR5 MODEL* OR PROBALISTIC NEAR3 MODEL* OR (STABLE* OR DENOISING) NEAR3 DIFFUSION* OR (DIFFUSION NEAR3 MODEL* OR (PROGAGATION OR DIFFUSION) SEQ2 (STOCHASTIC* OR PROBALISTIC* OR PROBABILITY) SEQ2 MODEL* OR PROPAGATION SEQ2 STOCHASTIC SEQ2 MODEL* OR DISPERSION SEQ2 STOCHASTIC SEQ2 MODEL* OR SCORE_BASED SEQ2 GENERATIVE SEQ2 MODEL*))

GenAI modes:

Image, video

(CPC=(A61B 5/1128, B23Q 17/249, G01M 11/065, G01N 15/1463, G01N 15/1475, G01N 21/8851, G01N2203/0647, G02B 7/365, G02B 21/244, G05D 1/0251, G06F 16/583, G06F 16/5862, G06F 16/70, G06F 16/78, G06F 16/783, G06F 16/7864, G06F2212/455, G06T, G06T 1, G06T 1/20, G06T 3, G06T 3/4046, G06T 5, G06T 7, G06T 9, G06T 9/002, G06T 11, G06T 13, G06T 15, G06T 17, G06T 19, G06T2207, G06T2207/00, G06T2207/20, G06T2207/20081, G06T2207/20084, G06V 10/70, H04N 5/2226, H04N 5/23229, H04N 5/23254, H04N2013/0074, Y10S 128/922, Y10S 707/914) OR FTERMSMART=(2H029/CD01, 2H029/DB12, 2H070/BB12, 2H095/AC02, 2H106/AA83, 2H109/BA06, 2K103/BB05, 2K203/GB22, 4C161/WW04, 4C601/JC, 5B057/DA, 5B057/DB, 5B057/DC, 5C020/AA13, 5C079/LA40, 5C122/FH, 5C122/FH17, 5C122/FH18) OR IPC=(G06F 16/58, G06F 16/583, G06F 16/70, G06F 16/78, G06F 16/783, G06T, G06T 1, G06T 1/20, G06T 3, G06T 5, G06T 7, G06T 9, G06T 11, G06T 13, G06T 15, G06T 17, G06T 19, G06V 10/70)) OR(TITLEABSTRACTCLAIMS=((IMAGE OR VIDEO) NEAR3 (SYNTHESE* OR CREAT* OR GENERAT*) OR IMAGE_TO_IMAGE OR IMAGE STYLE TRANSFER* OR TEXT_TO_IMAGE* OR VIDEO_TO_VIDEO*)) AND (IPC=(G06F, G06T, G06T 1, G06T 3, G06T 7, G06T 9, G06T 13, G06T 15, G06T 17, G06T 19, G06V) OR CPC=(A61B 5/1128, B23Q 17/249, G01M 11/065, G01N 15/1463, G01N 15/1475, G01N 21/8851, G01N2203/0647, G02B 7/365, G02B 21/244, G05D 1/0251, G06F, G06F 16/70, G06F2212/455, G06T, G06T 1, G06T 3, G06T 7, G06T 9, G06T 13, G06T 15, G06T 17, G06T 19, G06T2207, G06T2207/00, G06V, H04N 5/2226, H04N 5/23229, H04N 5/23254, H04N2013/0074, Y02D 10/00, Y10S 128/922, Y10S 707/914))

Text

(CPC=(G05B2219/13106, G06F 16/243, G06F 16/24522, G06F 16/3329, G06F 16/3334, G06F 16/3335, G06F 16/3337, G06F 16/3338, G06F 16/3344, G06F 16/3347, G06F 16/345, G06F 16/36, G06F 16/367, G06F 16/374, G06F 16/90332, G06F 17/20, G06F 40, G06F 40/16, G06F 40/20, G06F 40/205, G06F 40/279, G06F 40/30, G06F 40/40, G06F 40/56) OR IPC=(G06F 16/36, G06F 17/20, G06F 40, G06F 40/16, G06F 40/20, G06F 40/205, G06F 40/279, G06F 40/30, G06F 40/40, G06F 40/56)) OR (TITLEABSTRACTCLAIMS=(PARAPHRASING OR (REWORDING OR REPHRASING) NEAR5 (WORD* OR SENTENCE* OR PARAGRAPH*) OR (SEMANTIC* OR NATURAL NEAR3 LANGUAGE) OR LANGUAGE NEAR3 (GENERAT* OR PRODUCTI*) OR TEXT* NEAR3 SUMMARI?ATI*)) AND (IPC=(G06F) OR CPC=(G06F, Y02D 10/00))

Speech, music, voice

(CPC=(A63B2071/068, A63F2300/1081, B60G2401/19, B60R 25/257, B65H2551/132, B66B2201/4646, G01C 21/3608, G03G2215/00122, G05B2219/40531, G06F 3/167, G06F 16/7834,

G10H 1/0025, G10H2210, G10H2240, G10H2250, G10L, G10L 13, G10L 15, G10L 15/08, G10L 15/24, G10L 15/26, G10L 17, G10L 25, G10L 99, H04M 1/642, H04M 1/6505, H04M2201/39, H04M2201/40, H04Q2213/13378, H04Q2213/378, Y10S 379/907) OR IPC=(G10L, G10L 13, G10L 15, G10L 15/08, G10L 15/24, G10L 15/26, G10L 17, G10L 25, G10L 99) OR FTERMSMART=(2C028/BB07, 2H270/QA36, 5B056/HH05, 5B089/KH16, 5C164/PA43, 5C164/PA46, 5D015, 5D045, 5D102/HC33, 5D108/BC17, 5H220/GG06, 5K015/AA06, 5K025/EE26, 5K027/HH20, 5K034/FF07, 5K038/GG04, 5K049/CC10, 5K127/CA27, 5K201/EC09)) OR(TITLEABSTRACTCLAIMS=((VOICE OR SPEECH) NEAR3 (SYNTHESIS* OR GENERAT* OR ANALYSIS*) OR SPEECH_TO_TEXT OR TEXT_TO_SPEECH* OR SPEECH* NEAR4 RECOG* OR VOICE* NEAR4 RECOG* OR VOICE* NEAR4 PRINT* OR VOICEPRINT*)) AND (IPC=(G06F) OR CPC=(G06F, G06F 3/01, Y02D 10/00))

Software, code

(CPC=(G06F 8/00, G06F 8/20, G06F 8/30, G06F 8/40, G06F 8/60, G06F 8/70, G06F 11/36) OR IPC=(G06F 8/00, G06F 8/20, G06F 8/30, G06F 8/40, G06F 8/60, G06F 8/70, G06F 11/36)) OR (TITLEABSTRACTCLAIMS=((SOFTWARE OR CODE) NEAR3 (COMPLETION* OR GENERAT* OR DEVELOPMENT* OR PROGRAMMING))) AND (IPC=(G06F) OR CPC=(G06F, Y02D 10/00))

3D image models

((CPC=(G06T 13/20, G06T 13/40, G06T 15, G06T 15/04, G06T 15/20, G06T 17, G06T 17/20, G06T 19, G06T 19/003, G06T 19/20) OR IPC=(G06F 3/04815, G06T 13/20, G06T 13/40, G06T 15, G06T 15/04, G06T 15/20, G06T 17, G06T 17/20, G06T 19, G06T 19/20) OR FTERMSMART=(5B050/BA09, 5B050/EA27)) OR (TITLEABSTRACTCLAIMS=(TEXT_TO_NERF OR TEXT_TO_3D OR (((THREE_D OR "3D") NEAR3 IMAGE*) NEAR3 MODEL*))))

Molecules, genes, proteins

(IPC=(C40B, C40B 10, C40B 20, C40B 30, C40B 30/00, C40B 30/02, C40B 30/04, C40B 30/08, C40B 30/10, C40B 40, C40B 50, C40B 50/02, C40B 60, C40B 70, C40B 80, C40B 99, G06F 19/10, G06F 19/16, G06F 19/18, G06F 19/22, G06F 19/28, G16B, G16B 20/00, G16B 30/00, G16B 40/00, G16C, G16C 10, G16C 20, G16C 60, G16C 99, G16CMISS) OR TITLEABSTRACTCLAIMSDESCRIPTION=((COMPUTATIONAL W2 CHEMISTRY) OR CHEMINFORMATICS OR ((AB D2 INITIO) AND CHEM*) OR (DENSITY D2 FUNCTIONAL D2 THEORY) OR (MOLECULAR D2 MECHANICS) OR (QUANTUM D2 CHEMISTRY) OR CHEMOINFORMATICS OR (DRUG* NEAR6 (DEVELOPMENT* OR TARGETING* OR DESIGN*)) NEAR10 (COMPUT* OR SOFTWARE* OR ALGORITHM*) OR (SYSTEMS* NEAR6 BIOLOGY*) OR PHARMACOPHOR*) OR CPC=(B01J2219/00689, B01J2219/00695, C04B2235/6026, C07K2299, C12N 15/1037, C12N 15/1093, C40B, C40B 10, C40B 20, C40B 30/00, C40B 30/02, C40B 30/04, C40B 30/08, C40B 30/10, C40B 40, C40B 50, C40B 50/02, C40B 60, C40B 70, C40B 80, C40B 99, G06F 19/10, G06F 19/16, G06F 19/18, G06F 19/22, G06F 19/28, G06F 19/70, G06F 19/706, G16B, G16B 20/00, G16B 30/00, G16B 40/00, G16C, G16CMISS, Y10S 423/05, Y10S 977/808)) OR ((IPC=(C01, C07B, C07C, C07D, C07F, C07G, C08, C21) OR CPC=(C01, C07B, C07C, C07D, C07F, C07G, C08, C21)) AND TAG=("ECONSIGHT TECHNOLOGY FIELDS\IC5.3.9. NEURAL NETWORKS & DEEP LEARNING"))

GenAI applications:

Physical sciences and engineering

TITLEABSTRACTCLAIMS= ((PHYSICAL NEAR2 SCIENCES) OR (ARCHAEOLOGY) OR (ASTRONOMY) OR (CHEMISTRY) OR ((EARTH OR ATMOSPHERIC) NEAR2 SCIENCES) OR (ENVIRONMENTAL NEAR2 SCIENCES) OR (COMPUTER_AIDED DESIGN) OR (PHYSICS) OR (MATHEMATICS) OR (ELECTRONICS) OR (WIRELESS DEVICE?)) OR IPC=(C OR D OR E OR F01 OR F02 OR F03 OR F04 OR F15 OR F16 OR F17) OR CPC=(G16C20/70 OR C OR D OR E OR F01 OR F02 OR F03 OR F04 OR F05 OR F15 OR F16 OR F17)

Industry and manufacturing

TITLEABSTRACTCLAIMS= (INDUSTRY OR INDUSTRIAL OR (SUPPLY NEAR3 CHAIN) OR MANUFACTURING OR (MACHINE NEAR3 TOOL?)) OR CPC=(G06Q10/06 OR G06Q10/08 OR G06Q50/04 OR G06Q50/28) OR IPC=(G06Q10/06 OR G06Q10/08 OR G06Q50/04 OR G06Q50/28)

Life and medical sciences

TITLEABSTRACTCLAIMS=((LIFE NEAR2 SCIENCE?) OR HEALTH OR BIOLOGY OR HEALTHCARE OR MEDICAL OR (COMPUTATIONAL BIOLOGY) OR (MOLECULAR NEAR2 ("SEQUENCE ANALYSIS" OR EVOLUTION)) OR (RECOGNITION NEAR2 GENES) OR TRANSCRIPTOMICS OR "BIOLOGICAL NETWORKS" OR GENOTYPING OR PROTEOMICS OR GENOMICS OR BIOINFORMATICS OR METABOLOMICS OR METABONOMICS OR GENETICS OR PROTEOMICS OR TRANSCRIPTOMICS OR (DRUG DISCOVERY)) OR CPC=(G16B40 OR A61 OR G16H50/20) OR IPC=(A61 OR G16B40 OR G16H50/20)

Telecommunications

TITLEABSTRACTCLAIMS=(TELECOM? OR TELEPHON? OR PHONE? OR (COMMUNICATION? NEAR2 NETWORK?) OR RADIO OR PHONE? OR WIRELESS OR (COMMUNICATION NEAR2 SATELLITE?) OR TELEVISION) OR CPC=(H04L2012/5686 OR H04L2025/03464 OR H04L25/0254 OR H04L25/03165 OR H04L41/16 OR H04L45/08 OR H04N21/4662 OR H04Q2213/054 OR H04Q2213/13343 OR H04Q2213/343 OR H04R25/507) OR IPC=(H04L12/70 OR H04L25/02 OR H04L25/03 OR H04L12/24 OR H04L12/751 OR H04N21/466 OR H04R25)

Transportation

TITLEABSTRACTCLAIMS=(TRANSPORTATION OR VEHICLE? OR AEROSPACE OR SPACECRAFT OR SPACEFLIGHT OR ROADS OR AUTOMOBILE? OR AUTOMOTIVE? OR TRUCKS OR RAILWAYS OR TRAINS OR FREIGHT OR AIRWAYS OR WATERWAYS OR WATERCRAFT? OR AVIONICS OR AERONAUTICS OR AIRCRAFT? OR DRONE? OR UAV OR HELICOPTER? OR BOAT OR BOATS OR (BUS NEAR2 STATION?) OR AUTOBUS OR MOTORBUS OR STREETCAR OR TROLLEY) OR CPC=(B60W30/06 OR B60W30/10 OR B60W30/12 OR B60W30/14 OR B60G2600/1876 OR B60G2600/1878 OR B60G2600/1879 OR B62D015/0285 OR B64G2001/247 OR G06T2207/30248 OR G06T2207/30236 OR G05D001 OR B64C2201) OR IPC=(B60W30/06 OR B60W30/10 OR B60W30/12 OR B60W30/14 OR B62D15/02 OR B64G1/24 OR G05D1)

Energy management

TITLEABSTRACTCLAIMS=((ENERGY OR POWER) NEAR2 (MANAGEMENT OR PLANNING OR CHALLENGE)) OR -GRID? OR (NEAR2 GRID?) OR CPC=(G01R 31/2846, G01R 31/2848, G01R 31/3651, G21, H01J2237/30427, H01M 8/04992, H02, H02H 1/0092, H02P 21/0014, H02P 23/0018, H03H2017/0208, H03H2222/04, H04W 52) OR IPC=(G21, H01M 8/04992, H02, H03H 17/02, H04W 52)

Agriculture

TITLEABSTRACTCLAIMS=((AGRICULTURE OR AGRICULTURAL OR CULTIVATE* OR BREEDING OR AGRONOMY OR PESTICIDE? OR AGROCHEMICAL? OR FERTILIZER?)) OR CPC=(A01) OR IPC=(A01)

Security

TITLEABSTRACTCLAIMS=(SECURITY OR SURVEILLANCE OR (INVESTIGATION TECHNIQUES) OR (EVIDENCE COLLECTION) OR (NETWORK FORENSICS) OR (SYSTEM FORENSICS) OR (DATA RECOVERY) OR (COMPUTER FORENSICS) OR (BIOMETRICS) OR (CYBERSECURITY)) OR CPC=(G06F21 OR A61B5/117 OR H04W 12) OR IPC=(G06F21 OR A61B5/117 OR H04W 12)

Entertainment

TITLEABSTRACTCLAIMS=(ENTERTAINMENT OR ((VIDEO OR COMPUTER OR ELECTRONIC OR ONLINE) NEAR2 (GAME? OR GAMING))) OR CPC=(A63) OR IPC=(A63)

Business solutions

TITLEABSTRACTCLAIMS=((ELECTRONIC NEAR2 (COMMERCE? OR "DATA INTERCHANGE" OR "FUNDS TRANSFER")) OR (ENTERPRISE NEAR2 (COMPUTING OR "INFORMATION SYSTEMS" OR "RESOURCE PLANNING" OR APPLICATIONS OR (ARCHITECTURE NEAR2 (MANAGEMENT

OR FRAMEWORKS OR MODELING)) OR ONTOLOGIES OR TAXONOMIES OR VOCABULARIE OR "DATA MANAGEMENT" OR INTEROPERABILITY)) OR (CUSTOMER NEAR2 SERVICE?) OR (DIGITAL CASH) OR (E-COMMERCE INFRASTRUCTURE) OR (ONLINE NEAR2 (SHOPPING OR BANKING OR AUCTIONS)) OR (SECURE ONLINE TRANSACTIONS) OR (MARKETING) OR (VIDEO CONTENT DISCOVERY) OR (RECRUITMENT) OR (INTRANETS) OR (EXTRANETS) OR (DATA CENTERS) OR ((BUSINESS PROCESS) NEAR2 (MANAGEMENT OR MODELING OR MONITORING OR " CROSS-ORGANIZATIONAL")) OR (BUSINESS NEAR2 (INTELLIGENCE OR RULES)) OR ((SERVICE-ORIENTED OR IT OR EVENT-DRIVEN) SEQ2 ARCHITECTURES) OR (BUSINESS-IT ALIGNMENT) OR (IT GOVERNANCE) OR (INFORMATION NEAR2 (INTEGRATION OR INTEROPERABILITY))) OR CPC=(G06Q 10/10, G06Q 20, G06Q 30) OR IPC=(G06Q 10/10, G06Q 20, G06Q 30)

Military

TITLEABSTRACTCLAIMS=(MILITARY OR WARFARE OR CYBERWARFARE OR TACTICAL OR TACTICS OR ARMY OR WEAPON? OR BATTLE? OR BATTLEFIELD? OR PEACE OR PEACEKEEPING) OR CPC=(B63G, B64D 7, F41, F42, G01S 19/18) OR IPC=(B63G, B64D 7, F41, F42, G01S 19/18)

Education

TITLEABSTRACTCLAIMS= (EDUCATION OR EDUCATIONAL OR (DIGITAL NEAR2 LIBRARY) OR ((CHILD? OR CHILDREN OR PERSON OR PEOPLE OR STUDENT?) NEAR2 INSTRUCTION?) OR ((INTERACTIVE OR COLLABORATIVE OR DISTANCE) NEAR2 LEARNING) OR E-LEARNING OR (LEARNING MANAGEMENT SYSTEM?)) OR CPC=(G09B OR G06Q50/20) OR IPC=(G09B OR G06Q50/20)

Document management and publishing

(TITLEABSTRACTCLAIMS=((DOCUMENT NEAR2 (MANAGEMENT OR EDITING OR PROCESSING OR SEARCHING OR METADATA OR CAPTURE OR ANALYSIS OR SCANNING OR SCRIPTING OR PREPARATION)) OR (TEXT? NEAR2 (MANAGEMENT OR EDITING OR PROCESSING OR SEARCHING)) OR (VERSION CONTROL) OR (GRAPHICS NEAR2 (RECOGNITION OR INTERPRETATION)) OR (((OPTICAL CHARACTER) OR (ONLINE HANDWRITING)) NEAR2 RECOGNITION) OR (MARKUP LANGUAGE?) OR (HYPERTEXT LANGUAGE?) OR (ANNOTATION) OR ((MULTIMEDIA OR MIXED-MEDIA) NEAR2 CREATION) OR (IMAGE COMPOSITION) OR ((HYPERTEXT OR HYPERMEDIA) NEAR2 CREATION)) OR TITLEABSTRACTCLAIMS=((PUBLISHING OR (COPY NEAR2 EDITING) OR PUBLICATION? OR EDITORIAL) OR ((AFFECTIVE NEAR2 COMPUTING) OR (AFFECTIVE NEAR2 (RECOGNITION OR ESTIMATION OR STATE?)) OR ((ARTIFICIAL NEAR2 EMOTION*) NEAR2 INTELLIGENCE) OR ((PHYSIOLOGICAL NEAR3 MARKER) NEAR3 RECOGNITION) OR (EMOTION NEAR2 AI))) OR CPC=(A61B 5/165, G06F 40/10, G10L 25/63) AND IPC=(G06F 40/10, G10L 25/63))

Personal devices, computing and HCI

(TITLEABSTRACTCLAIMS=((PERSONAL NEAR2 COMPUTER?) OR (WORD NEAR2 PROCESSOR?) OR SPREADSHEETS OR MICROCOMPUTER? OR (HUMAN-MACHINE) OR (TOUCH NEAR2 SCREEN?) OR ((DISPLAY OR DISPLAYS) NEAR2 (TECHNOLOGY OR SYSTEM? OR APPARATUS)) OR (USER NEAR2 INTERFACE?)) OR TITLEABSTRACTCLAIMS=((AFFECTIVE NEAR2 COMPUTING) OR (AFFECTIVE NEAR2 (RECOGNITION OR ESTIMATION OR STATE?)) OR ((ARTIFICIAL NEAR3 EMOTION??) NEAR3 INTELLIGENCE) OR ((PHYSIOLOGICAL NEAR3 MARKER) NEAR3 RECOGNITION) OR (EMOTION NEAR2 AI))) OR IPC=(G10L 25/63) OR CPC=(A61B 5/165, G10L 25/63)

Banking and finance

TITLEABSTRACTCLAIMS=(FINTECH OR BANKING OR FINANCE OR FINANCING OR INSURANCE? OR REINSURANCE? OR INSURABLE? OR TRADING OR LIABILITY) OR CPC=(G06Q40) OR IPC=(G06Q40)

Arts and humanities

TITLEABSTRACTCLAIMS= ((FINE ARTS) OR (PERFORMING ARTS) OR (ARCHITECTURE NEAR2 BUILDING?) OR (LANGUAGE TRANSLATION) OR (MEDIA ARTS) OR (MUSIC?) OR CINEMA OR

CINEMATOGRAPHY OR MOVIE OR WRITTING OR PAINTING? OR SCULPTING OR PHOTOGRAPHY OR THEATRE)

Computing in government

TITLEABSTRACTCLAIMS=(GOVERNMENT OR VOTING OR ELECTION OR E-GOVERNMENT OR (PUBLIC NEAR2 (POLICY OR POLICIES))) OR CPC=(G06Q50/26) OR IPC=(G06Q50/26)

Networks/smart cities

TITLEABSTRACTCLAIMS=((((SOCIAL OR DEVICE?) NEAR2 NETWORK?) OR IOT OR (INTERNET NEAR2 THINGS) OR SMART_CITY OR SMART_CITIES OR (SMART NEAR2 (CITY OR CITIES OR GRID? OR HOME? OR TRANSPORT? OR DEVICE? OR SENSOR?)) OR (VIRTUAL NEAR2 PLANTS))

Cartography

TITLEABSTRACTCLAIMS=(CARTOGRAPHY OR GEOGRAPHIC? OR TOPOGRAPHY OR TOPOGRAPHICS) OR IPC=(G06F 16/29) OR CPC=(G06F 16/29)

Industrial property, law, social and behavioral sciences

TITLEABSTRACTCLAIMS= (((BEHAVIOR OR BEHAVIORAL) NEAR2 SCIENCE?) OR (SOCIAL NEAR2 SCIENCE?) OR (LEGAL NEAR3 (STUDIES OR KNOWLEDGE OR INFORMATION? OR DOCUMENT? OR EVALUATION? OR CITATION? OR OPINION? OR TEXT? OR ARGUMENT? OR CONSULTANCY OR RIGHT? OR ISSUE? OR RISK? OR RESEARCH?? OR MATTER? OR CASE? OR JUDGMENT? OR DISCUSSION? OR CONCEPT? OR ACTION? OR STANDARD?)) OR LAWYER? OR JUDICIAL? OR LEGISLATION? OR ANTHROPOLOGY OR ETHNOGRAPHY OR PSYCHOLOGY OR ECONOMICS OR SOCIOLOGY)

A.5 Prompts

Almost 100 prompts for various concepts of GenAI and GenAI application areas were used in EconSight's advanced AI search algorithms to help retrieve GenAI patents with high recall. The prompts below were used as the second stage in the GenAI patent retrieval approach discussed in detail in Appendix A.1.

Concept_1 = "Generative AI, generative artificial intelligence for 3D creation or three-dimensional designs."

Concept_2 = "Generative AI, generative artificial intelligence for accounting."

Concept_3 = "Generative AI, generative artificial intelligence in Biotech."

Concept_4 = "Generative AI, generative artificial intelligence for Advertisement."

Concept_5 = "Generative AI, generative artificial intelligence for AI understanding."

Concept_6 = "Generative AI, generative artificial intelligence for algorithm discovery."

Concept_7 = "Generative AI, generative artificial intelligence for analysts."

Concept_8 = "Generative AI, generative artificial intelligence for analytical tasks."

Concept_9 = "Generative AI, generative artificial intelligence for app design or creation."

Concept_10 = "Generative AI, generative artificial intelligence for app creation."

Concept_11 = "Generative AI, generative artificial intelligence for architecture."

Concept_12 = "Generative AI, generative artificial intelligence for bookkeeping."

Concept_13 = "Generative AI, generative artificial intelligence for brain communication."

Concept_14 = "Generative AI, generative artificial intelligence for converting brain signals to images."

Concept_15 = "Generative AI, generative artificial intelligence for converting brain signals to text."

Concept_16 = "Generative AI, generative artificial intelligence for business operations."

Concept_17 = "Generative AI, generative artificial intelligence for chatbots."

Concept_18 = "Generative AI, generative artificial intelligence for computer interaction."

Concept_19 = "Generative AI, generative artificial intelligence for contract analysis."

Concept_20 = "Generative AI, generative artificial intelligence for creating customer experiences."

Concept_21 = "Generative AI, generative artificial intelligence for cybersecurity."

Concept_22 = "Generative AI, generative artificial intelligence for design-to-code conversion."

Concept_23 = "Generative AI, generative artificial intelligence for diffusion modeling."

Concept_24 = "Generative AI, generative artificial intelligence for DNA prediction."

Concept_25 = "Generative AI, generative artificial intelligence for document-to-text conversion."

Concept_26 = "Generative AI, generative artificial intelligence for drug creation."

Concept_27 = "Generative AI, generative artificial intelligence for due diligence litigation."

Concept_28 = "Generative AI, generative artificial intelligence for education."

Concept_29 = "Generative AI, generative artificial intelligence for email generation."

Concept_30 = "Generative AI, generative artificial intelligence for fact-checking."

Concept_31 = "Generative AI, generative artificial intelligence for game design or creation."

Concept_32 = "Generative AI, generative artificial intelligence for gaming design or creation."

Concept_33 = "Generative AI, generative artificial intelligence with GANs (Generative Adversarial Networks)."

Concept_34 = "Generative AI, generative artificial intelligence for image editing."

Concept_35 = "Generative AI, generative artificial intelligence for image-to-text conversion."

Concept_36 = "Generative AI, generative artificial intelligence for image-to-video conversion."

Concept_37 = "Generative AI, generative artificial intelligence for latent diffusion."

Concept_38 = "Generative AI, generative artificial intelligence for law and lawyers."

Concept_39 = "Generative AI, generative artificial intelligence for LLMs (Large Language Models) in finance."

Concept_40 = "Generative AI, generative artificial intelligence for marketing."

Concept_41 = "Generative AI, generative artificial intelligence for medical doctors."

Concept_42 = "Generative AI, generative artificial intelligence for meme creation."

Concept_43 = "Generative AI, generative artificial intelligence for modeling."

Concept_44 = "Generative AI, generative artificial intelligence for molecule modeling."

Concept_45 = "Generative AI, generative artificial intelligence for music."

Concept_46 = "Generative AI, generative artificial intelligence for mute people communication."

Concept_47 = "Generative AI, generative artificial intelligence for generating presentations from language."

Concept_48 = "Generative AI, generative artificial intelligence for generating images from text prompts."

Concept_49 = "Generative AI, generative artificial intelligence for generating videos from text prompts."

Concept_50 = "Generative AI, generative artificial intelligence for protein design."

Concept_51 = "Generative AI, generative artificial intelligence for protein modeling."

Concept_52 = "Generative AI, generative artificial intelligence for real estate."

Concept_53 = "Generative AI, generative artificial intelligence for realistic data generation."

Concept_54 = "Generative AI, generative artificial intelligence for recommendation generation."

Concept_55 = "Generative AI, generative artificial intelligence for regulatory compliance."

Concept_56 = "Generative AI, generative artificial intelligence for Reinforcement Learning."

Concept_57 = "Generative AI, generative artificial intelligence for RPA (Robotic Process Automation)."

Concept_58 = "Generative AI, generative artificial intelligence for social media content."

Concept_59 = "Generative AI, generative artificial intelligence for speech."

Concept_60 = "Generative AI, generative artificial intelligence for speech imitation."

Concept_61 = "Generative AI, generative artificial intelligence for stable diffusion."

Concept_62 = "Generative AI, generative artificial intelligence for storytelling."

Concept_63 = "Generative AI, generative artificial intelligence for summarization."

Concept_64 = "Generative AI, generative artificial intelligence for tattoo generation."

Concept_65 = "Generative AI, generative artificial intelligence for tax documents."

Concept_66 = "Generative AI, generative artificial intelligence for text-to-3D conversion."

Concept_67 = "Generative AI, generative artificial intelligence for text-to-app conversion."

Concept_68 = "Generative AI, generative artificial intelligence for text-to-code conversion."

Concept_69 = "Generative AI, generative artificial intelligence for text-to-design conversion."

Concept_70 = "Generative AI, generative artificial intelligence for text-to-image conversion."

Concept_71 = "Generative AI, generative artificial intelligence for text-to-level conversion."

Concept_72 = "Generative AI, generative artificial intelligence for text-to-medical advice."

Concept_73 = "Generative AI, generative artificial intelligence for text-to-slides conversion."

Concept_74 = "Generative AI, generative artificial intelligence for text-to-software conversion."

Concept_75 = "Generative AI, generative artificial intelligence for text-to-speech conversion."

Concept_76 = "Generative AI, generative artificial intelligence for text-to-video conversion."

Concept_77 = "Generative AI, generative artificial intelligence for text-to-voice conversion."

Concept_78 = "Generative AI, generative artificial intelligence for text-to-website conversion."

Concept_79 = "Generative AI, generative artificial intelligence with Transformers."

Concept_80 = "Generative AI, generative artificial intelligence for travel maps."

Concept_81 = "Generative AI, generative artificial intelligence for urban planning."

Concept_82 = "Generative AI, generative artificial intelligence for user interface creation."

Concept_83 = "Generative AI, generative artificial intelligence for vector generation from video."

Concept_84 = "Generative AI, generative artificial intelligence for video creation."

Concept_85 = "Generative AI, generative artificial intelligence for video-to-image conversion."

Concept_86 = "Generative AI, generative artificial intelligence for video-to-text conversion."

Concept_87 = "Generative AI, generative artificial intelligence for video to 3D."

Concept_88 = "Generative AI, generative artificial intelligence for voice cloning."

Concept_89 = "Generative AI, generative artificial intelligence for website creation."

Concept_90 = "Generative AI, generative artificial intelligence."

Concept_91 = "Generative AI, generative artificial intelligence with neural style transfer (NST)."

Concept_92 = "Generative AI, generative artificial intelligence with diffusion models."

Concept_93 = "Generative AI, generative artificial intelligence with variational autoencoder (VAE)."

Concept_94 = "Generative AI, generative artificial intelligence with autoregressive models."

Concept_95 = "Generative AI, generative artificial intelligence with large language models (LLMs)."

Concept_96 = "Generative AI, generative artificial intelligence with GPT-3, Chat GPT."

Concept_97 = "Generative AI, generative artificial intelligence with GPT-4."

A.6 Scientific publication query with The Lens

We used The Lens (Cambia 2024) as a bibliographical analytics tool for scientific publications. This is a free service, using trusted open bibliographical sources with an extensive coverage of scientific publications, making possible an easy reproducibility of the present analysis.

The base query has been built as follows:

Fields	Search terms	Comment
publication year range	2010-2023	2023 is entirely included, 2024 is excluded
title, abstract, keyword, field_of_study	"GENERATIVE AI" OR "GENERATIVE ARTIFICIAL INTELLIGENCE" OR "LARGE LANGUAGE MODEL" OR "LARGE LANGUAGE MODELS" OR "GENERATIVE ADVERSARIAL NETWORK" OR "GENERATIVE ADVERSARIAL NETWORKS" OR "GENERATIVE PRE-TRAINED TRANSFORMER" OR "DEEP GENERATIVE MODEL" OR "DEEP GENERATIVE MODELS" OR "DEEP GENERATIVE MODELING" OR "LARGE GENERATIVE MODEL" OR "LARGE GENERATIVE MODELS"	general terms related to generative AI
	"GPT-3" OR "CHATGPT" OR "GPT-4" OR "GPT4" OR ("LLAMA" AND "LANGUAGE MODEL") OR "DALL-E" OR "ALPHAFOLD" OR "GITHUB COPILOT"	mainstream foundation model names
		note: the search term "GPT3" (without dash separating the version number) is an ambiguous term (also a meteorological/climate model), so it was removed.
	"VARIATIONAL AUTOENCODER" OR "VARIATIONAL AUTOENCODERS"	related to image/3D generation
	OR "NEURAL RADIANCE FIELD" OR "NEURAL RADIANCE FIELDS"	
	OR "DENOISING DIFFUSION PROBABILISTIC MODEL" OR "DENOISING DIFFUSION PROBABILISTIC MODELS"	
	"TEXT-TO-IMAGE GENERATION" OR "GENERATIVE TEXT-TO-IMAGE MODELS" OR "GENERATIVE TEXT-TO-IMAGE MODEL"	related to text-based image generation
	"PROMPT ENGINEERING" OR "LLM PROMPTING" OR "TEXT-TO-IMAGE PROMPT"	related to model prompting
	"RETRIEVAL AUGMENTED GENERATION" OR "GENERATIVE CONVERSATIONAL AI" OR "GENERATIVE CONVERSATIONAL MODELS" OR "GENERATIVE CONVERSATIONAL MODEL"	related to conversational system/AI assistant
Title, keyword, field_of_study	"GENERATIVE MODELS" OR "GENERATIVE MODEL"	more restrictive to avoid some noise

The number of total results for the base query is 75,870 deduplicated scientific publications, as executed on January 20, 2024 with The Lens.

A.7 Mining software and dataset mentions in the non-patent literature corpus

In scientific publications, software and datasets are usually not formally cited like journal or conference articles. Citations to software and datasets are mostly informal mentions in the body of the text. As a consequence, they are invisible and unavailable in the large bibliographical and citation databases like Web of Science or Scopus. To measure realistic impact of datasets and software, it is necessary to identify their mentions with text mining techniques applied to the full texts of NPL documents.

The corpus of scientific publications used in the study is a set of 75,870 deduplicated publications produced as explained in Appendix 6. We used the open access subset of this corpus to identify automatically the mentions of software and datasets. These mentions can be then exploited to estimate what are the most impactful software and datasets in GenAI.

Our methodology relies on mature text mining tools resulting from several years of developments. These techniques are well-evaluated and able to scale to thousands of documents at a reasonable cost. The process is as follows:

- *Document full text acquisition:* The 75,870 publications of our corpus include 48,784 Open Access publications according to lens.org. We successfully downloaded 34,183 PDFs out of the full open access subset using the Unpaywall database (<https://unpaywall.org>).
- *Text mining of mentions:* The PDFs were processed by two tools, Softcite for extracting the software mentions (Softcite (2018–2024)) and DataStet for extracting dataset mentions DataStet (2022–2024).
- *Aggregation:* The extracted mentions (789,218 software mentions and 978,297 dataset mentions) were then aggregated and we kept the top 500 datasets and top 500 software.
- *Data cleaning:* We manually corrected these two sets to remove errors and merge the same software mentioned with name variants not handled at aggregation time.

The two mentioned recognizers rely on deep learning techniques, a BERT model called SciBERT, trained on scientific content. Softcite was trained on 5,000 manually annotated scientific articles and DataStet on two sets of respectively 22,000 and 6,000 manually annotated sentences. They perform with high accuracy, around 81% F1-score for software names and 89% F1-score for dataset names. More details on the implementation, evaluation and application of these tools are available in Lopez *et al.* (2021) and in Bassinet *et al.* (2023).

While the mentions were extracted from documents corresponding to less than half of the whole GenAI corpus, this is a very large and representative subset. Open Access publications are dominantly from scientific publishers (gold open access) and are not associated to loss of quality (STM 2023). Therefore, we can consider that the derived statistics provide a good approximation of the dataset and software relative impact.

A.8 Descriptions/example patents for GenAI applications

Software/other applications

Many GenAI patent families cannot be assigned to a specific application based on patent title, abstract and claims. These patents often describe topics such as search engines or chatbots that can in theory be used for many different use cases. These patents are assigned to the category "Software/other applications." In addition, there are also more specific use cases of GenAI within the software space. For example, it can help to automate many of the tasks involved in software development, such as coding, testing and debugging. This could free up developers to focus on more creative and strategic tasks. It can also allow users to code without programming

skills because text-based instructions can be used to create simple applications. Companies such as Microsoft are already selling GenAI for software engineering, including GitHub Copilot, which is now integrated with OpenAI's GPT-4. These patents are instead collected in the category software.

Example patent: WO2023172817 – SYSTEMS AND METHODS FOR A CONVERSATIONAL FRAMEWORK OF PROGRAM SYNTHESIS

Applicant: Salesforce

Abstract: Embodiments described herein provide a program synthesis framework that generates code programs through a multi-turn conversation between a user and a system. Specifically, the description to solve a target problem is factorized into multiple steps, each of which includes a description in natural language (prompt) to be input into the generation model as a user utterance. The model in turn synthesizes functionally correct subprograms following the current user utterance and considering descriptions and synthesized subprograms at previous steps. The subprograms generated at the multiple steps are then combined to form an output of program in response to the target problem.

Image:

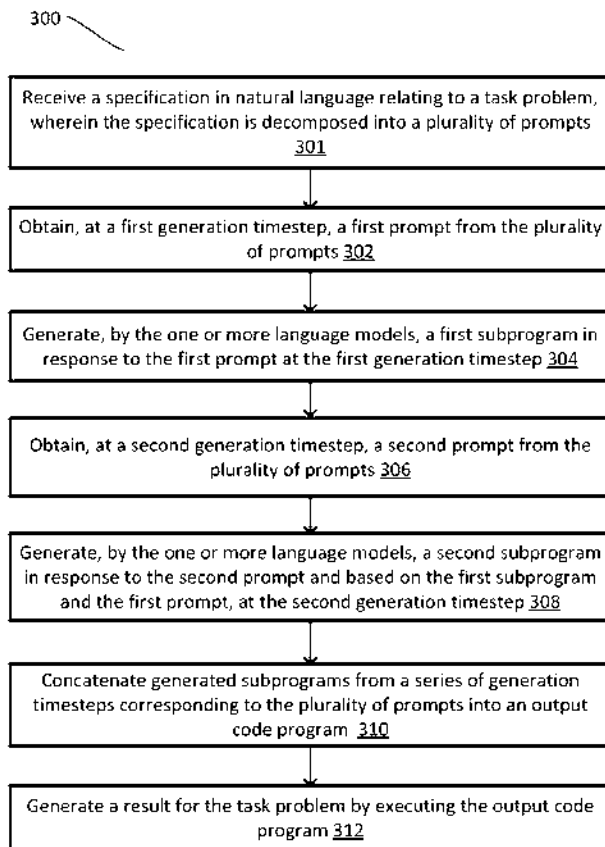

FIG. 3

Source: PATENTSCOPE.

Life sciences

GenAI has the potential to have a profound impact on life sciences in a number of ways: for example, biotech and pharma companies have begun to use GenAI foundation models in their research and development for what is known as generative design. Foundation models can speed up the process of developing new drugs by screening and designing molecules best suited for new drug formulation. Another promising area is personalized medicine. The ability to

generate insights and patterns from vast quantities of patient data will spark more personalized treatments. GenAI can also be used to create models of individual patients' genomes to predict their response to drugs. As a result, The McKinsey Global Institute (MGI) has estimated that the technology could generate US\$60 billion to US\$110 billion a year in economic value for the pharma and medical-product industries (McKinsey 2024b).

Example patent: US20230115171 – SYSTEM AND METHOD FOR GENERATING CUSTOMIZABLE MOLECULAR STRUCTURES FOR DRUG DISCOVERY

Applicant: Innoplexus

Abstract: A system and method for generating customizable molecular structures for drug discovery. The system includes a processor communicably coupled to a memory and executes a deep neural network based molecular encoding model. The processor receives input datasets of drug-like molecules from private and public databases and are employed as training dataset. The processor further executes a plurality of deep generative models configured to receive input data relating to small molecules which includes desirable molecules and undesirable molecules. The plurality of deep generative models generates molecular structures like the input desirable molecules. The deep neural network based molecular encoding model is configured to map similarities between the molecular structures generated. The deep neural network based molecular encoding model computes intra-model and inter-model distances. Further, the deep neural network based molecular encoding model samples the molecular structures generated from the plurality of deep generative models to obtain desired molecular structure.

Image:

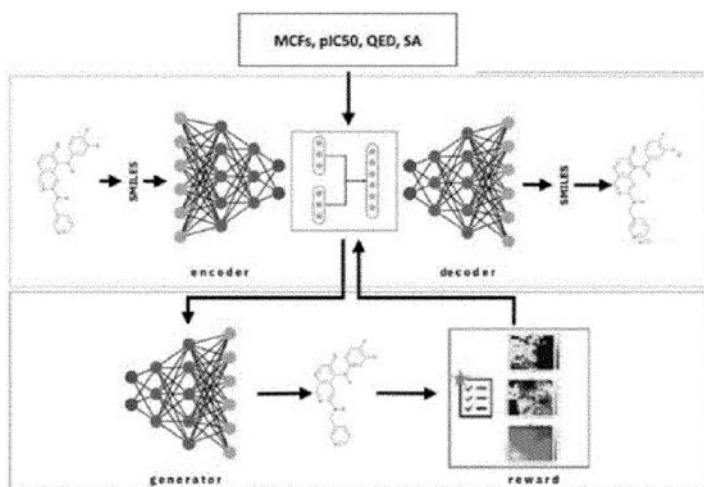

Source: PATENTSCOPE.

Document management and publishing

GenAI can be used to improve and automate document management and publishing. For example, it can help with the generation of documents such as contracts, invoices and reports. This can save businesses time and money. In addition, GenAI tools can create attractive marketing materials tailored to the interests of the target audience. GenAI is also capable of identifying and extracting key information from documents.

Example patent: US20230229866 – SYSTEM AND METHOD FOR MANAGEMENT OF LIFE CYCLE OF CONTRACTS

Applicant: Tata Consultancy Services

Abstract: Contracts are a fundamental tool for coordinating economic activity and need to be managed throughout the lifecycle of contracts. The existing methods are incomplete, expensive,

time-consuming, and error-prone. A method and system for management of lifecycle of contracts have been provided. The system leverages a combination of artificial intelligence (AI) techniques appropriate for different micro services in contract lifecycle management. The deep learning and natural language processing (NLP) techniques help in understanding of clauses of the contract, risk levels involved in the contract. The system is configured to automatically generate contracts for a customer based on the other criteria of the customer. The system also identifies alternate options to risky clauses and mandatory clauses to be included. The system is also configured to manage the workflows based on context of contract to seek exception approvals from appropriate stakeholders during contract creation and alert appropriate stakeholders on delivery governance issues.

Image:

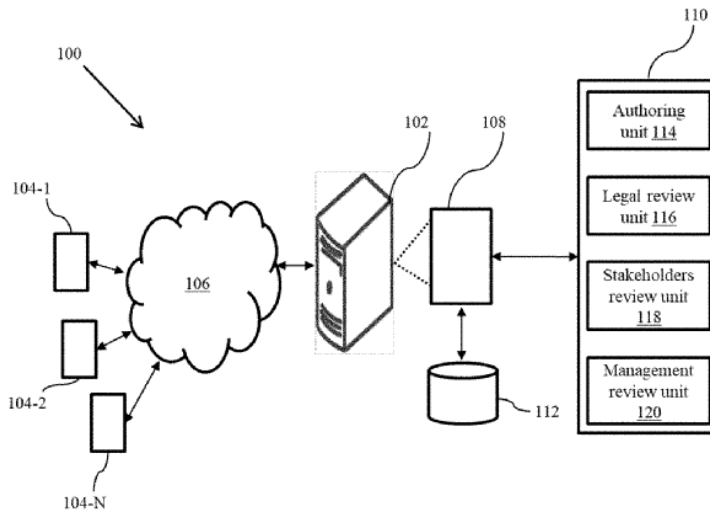

Source: PATENTSCOPE.

Business solutions

GenAI is expected to play an important part in many business areas. For example, it can transform the way organizations manage internal knowledge. I can empower employees to seamlessly access and retrieve stored knowledge by posing queries in a natural, conversational manner. This capability enables teams to swiftly gather relevant information, enabling them to make sound decisions and devise effective strategies with greater agility. GenAI will also transform the customer operations landscape, enhancing both efficiency and customer satisfaction. The technology has already garnered significant adoption in the customer service domain, for example as GenAI-fueled chatbots that give immediate and personalized responses to complex customer inquiries.

Example patent: WO2022201195 – RETAIL ASSISTANCE SYSTEM FOR ASSISTING CUSTOMERS

Applicant: RN Chidakashi Technologies Private Limited

Abstract: A system and method for retail assistance system (102) for assisting customers while shopping in a retail store. The retail assistance system (102) is configured to detect one or more customers entering the retail store using an input unit, determine a personality profile of the one or more customers by analyzing a facial expression and one or more personal attributes of the one or more customers, determine one or more personalized recommendations for the one or more customers by analyzing the personality profile, past purchase history of the one or more customers, and visit history of the one or more customers in the retail store using a

machine learning model, and enable the at least one of customer to choose the one or more personalized recommendations.

Image:

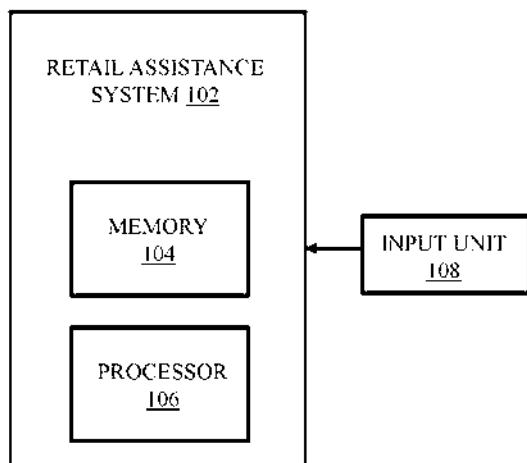

FIG. 1

Source: PATENTSCOPE.

Industry and manufacturing

There are numerous ways in which GenAI can play a role in various industries and in the manufacturing process. Traditional AI has already long been used for tasks such as anomaly detection, production analytics or setpoint optimization. GenAI now enables new features. For example, GenAI can be used to optimize designs of new products leading to cost reductions in production. Manufacturers are also adopting GenAI application programming interfaces to connect design and engineering tools to build digital twins of their facilities (Shapiro 2023). The Boston Consulting Group has identified three ways that GenAI can support the path to the factory of the future (BCG 2023):

- Assistance system: GenAI improves the efficiency of hands-on tasks such as programming or machine maintenance.
- Recommendation system: GenAI tools can also provide recommendations that help workers to identify the best methods for specific tasks, for example, by automatically creating text or images that provide maintenance instructions.
- Autonomous system: The third role of GenAI in factories is the role of autonomous systems. For example, GenAI will enable robots to translate operator prompts into a sequence of actions that the system then executes to perform material handling tasks. This would reduce the need for task- and environment-specific training, data labeling and frequent retraining. It therefore has the potential to reduce engineering costs, replace manual activities and increase productivity.

Example patent: US20220035346 – PREDICTIONS FOR A PROCESS IN AN INDUSTRIAL PLANT

Applicant: ABB

Abstract: To generate real-time or at least near real-time predictions for a process in an industrial plant, a set of neural networks are trained to create a set of trained models. The set of trained models is then used to output the predictions, by inputting online measurement results in an original space to two trained models whose outputs are fed, as reduced space inputs and reduced space initial states, to a third trained model. The third trained model processes the reduced space inputs to reduced space predictions. They are fed to a fourth trained model, which outputs the predictions in the original space.

Image:

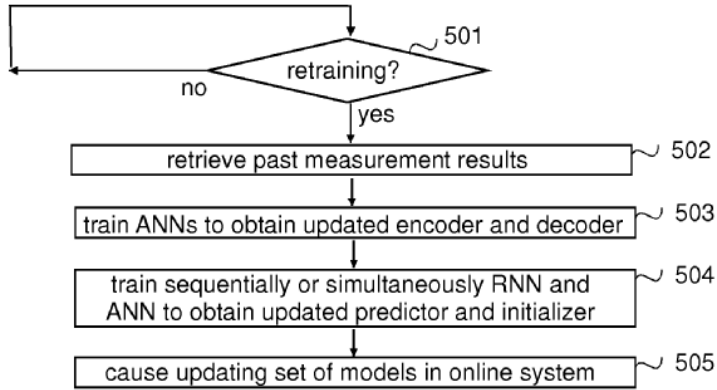

Source: PATENTSCOPE.

Transportation

GenAI has many use cases in transportation. For example, it will play a key role in autonomous driving. For this purpose, synthetic data are being employed to train autonomous vehicles, allowing them to be thoroughly tested in a realistic 3D virtual world (Nvidia 2023). GenAI models also allow the simultaneous generation of multiple scenarios, the prediction of future vehicle trajectories, and advancement of decision reasoning chains. These approaches enhance safety, efficiency and flexibility while significantly reducing risk and associated costs. Another use case will be in-car personal assistants with GenAI skills promising to boost navigation and infotainment to new heights. GenAI can also optimize public transportation systems. By analyzing vast amounts of data on factors like population density, traffic patterns and passenger preferences, AI algorithms can devise more efficient routes and schedules for public transit networks.

Example patent: US20210294341 – METHOD AND APPARATUS FOR GENERATING U-TURN PATH IN DEEP LEARNING-BASED AUTONOMOUS VEHICLE

Applicants: Hyundai, Kia

Abstract: A method for generating a U-turn path in an autonomous vehicle includes calculating a drivable area, generating multiple paths drivable in the drivable area, filtering a driving strategy path among the multiple paths based on deep learning, and determining a final path from the filtered candidate paths.

Image:

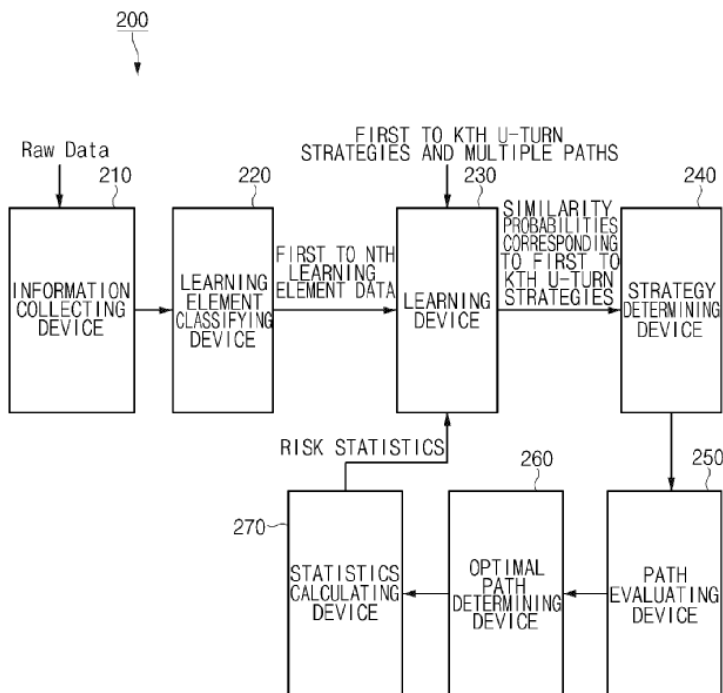

Source: PATENTSCOPE.

Security

The rise of GenAI in cybersecurity presents both challenges and opportunities. On the one hand, GenAI is used for valuable applications in cybersecurity, ranging from assisting threat hunters in retrieving relevant data for ongoing investigations to providing real-time insights that enhance vulnerability management processes. Similar to how GenAI can identify and replicate patterns in language, it can recognize and analyze patterns in cybersecurity threats and vulnerabilities. GenAI also plays a crucial role in enhancing system security by generating intricate, unique passwords or encryption keys that are nearly impenetrable to unauthorized access or decryption (Stanham 2023). On the other hand, there is also a clear downside – just as enterprises are harnessing GenAI to strengthen their cybersecurity defenses, cybercriminals are also employing this technology to devise sophisticated attack strategies that can bypass existing security measures. Mentions of GenAI on the dark web have risen significantly in 2023 (Ali and Ford 2023). Therefore, GenAI will accelerate the arms race between hackers and companies.

Example patent: US20200068398 – USE OF GENERATIVE ADVERSARIAL NETWORKS (GANs) FOR ROBUST TRANSMITTER AUTHENTICATION

Applicant: IBM

Abstract: A method is provided for transmitter authentication including generating a noise vector using a generative adversarial network generator model, wherein a signature of a first transmitter is embedded into a signal output by the first transmitter based at least on the noise vector; and using the signature to identify the first transmitter.

Image:

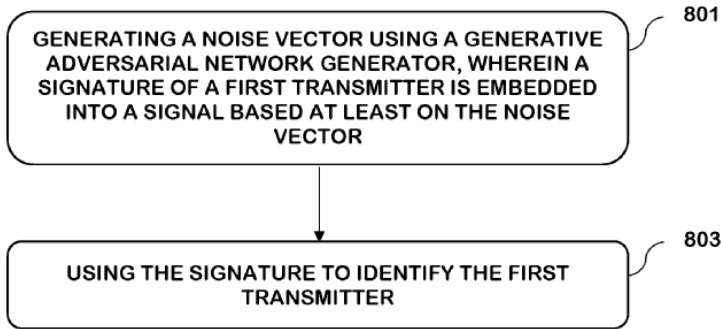

Source: PATENTSCOPE.

Telecommunications

In the telecom industry, GenAI can be used to transform various aspects of network operations, customer experience and service delivery. For example, telecommunications providers can leverage GenAI to streamline network operations and enhance customer satisfaction. By employing AI algorithms, network bottlenecks can be identified proactively, resource allocation can be optimized, and potential maintenance requirements can be anticipated. Additionally, GenAI can generate tailored service recommendations for customers, such as data plan upgrades or value-added services.

Example patent: US20230101761 – METHOD AND APPARATUS FOR DYNAMIC TONE BANK AND PERSONALIZED RESPONSE IN 5G TELECOM NETWORK

Applicant: IBM

Abstract: Generating a personalized automated voice response in a telecommunications network is provided. An incoming call from a caller for user equipment of an operator in the telecommunications network is identified. In response to identifying the incoming call, it is determined whether to provide an automated response to the incoming call. In response to determining to provide the automated response to the incoming call, a personalized response message from the operator of the user equipment to the caller is generated based on characteristics of communications between the caller and the operator of the user equipment. The personalized automated voice response comprising the personalized response message in a synthesized voice of the operator of the user equipment is generated. The personalized automated voice response is sent to the caller.

Image:

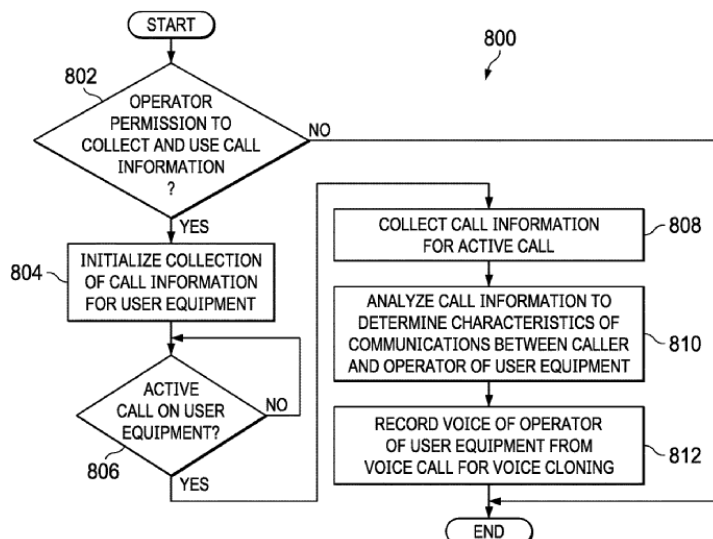

Source: PATENTSCOPE.

Personal devices

GenAI will also increasingly play an important role for personal devices such as mobile phones. GenAI models can run on a smartphone and analyze the data of one's device to anticipate one's next move – essentially transforming one's phone into a personal AI assistant. For example, Samsung Electronics revealed a new GenAI model called Samsung Gauss in November 2023 that is designed for AI applications on devices and will soon be available on new products (Samsung 2023). It can, among other things, help compose emails, translate content and generate or edit images.

Example patent: US20230223008 – METHOD AND ELECTRONIC DEVICE FOR INTELLIGENTLY READING DISPLAYED CONTENTS

Applicant: Samsung Electronics

Abstract: A method for intelligently reading displayed contents by an electronic device is provided. The method includes obtaining a screen representation based on a plurality of contents displayed on a screen of the electronic device. The method includes extracting a plurality of insights comprising at least one of intent, importance, emotion, sound representation and information sequence of the plurality of contents from the plurality of contents based on the screen representation. The method includes generating audio emulating the extracted plurality of insights.

Image:

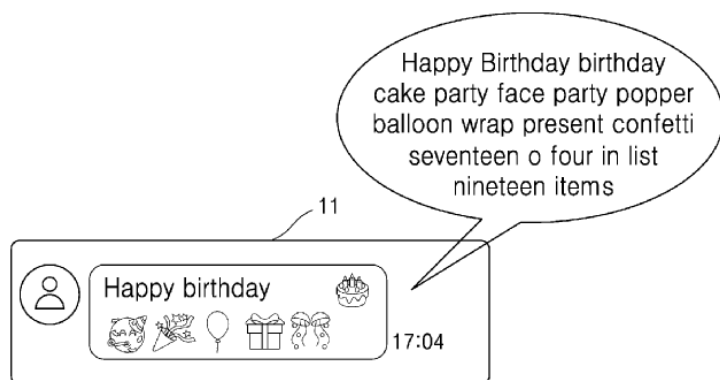

Source: PATENTSCOPE.

Banking and finance

Banks have been using traditional AI tools to automate tasks, generate predictions, detect fraud or for marketing purposes for many years. GenAI now brings new opportunities for established banks as well as for emerging fintech companies. For example, GenAI can serve as virtual experts to boost employee performance. For instance, Morgan Stanley is developing an AI assistant powered by GPT-4, designed to assist tens of thousands of wealth managers in swiftly locating and synthesizing answers from a comprehensive internal knowledge base (McKinsey 2023). GenAI can also improve the way banks manage their back-office operations. For example, GenAI tools can assist customer service representatives by transcribing conversations, extracting relevant information and generating notes during phone calls, allowing the human agent to concentrate on providing better customer service.

Example patent: CN116521840 – FINANCIAL QUESTION AUTOMATIC EXTRACTION AND REPLY METHOD AND SYSTEM BASED ON CONVOLUTIONAL NEURAL NETWORK

Applicant: Ping An Bank (Ping An Insurance)

Abstract: The invention provides a convolutional neural network-based financial question automatic extraction and reply method, which is characterized in that the convolutional neural

network-based financial question automatic extraction and reply method comprises the steps of retrieving a financial question containing a preset keyword from a preset channel; transcoding the financial question according to a first preset algorithm to form a question code; inputting the question code into a trained machine learning model to obtain answer information; and uploading and filling the answer information through the preset channel. In addition, the invention also provides a system and computer equipment thereof. According to the technical scheme, the problem that existing network financial question answering adopts manpower or cannot be intelligently answered is effectively solved.

Physical sciences and engineering

GenAI is expected to have an impact on various engineering and physical sciences disciplines, with the potential to enhance research, design and innovation. For example, by analyzing vast amounts of data on material properties and structures, AI algorithms can identify patterns and relationships that lead to the design of new materials with desired properties such as strength, conductivity and durability. However, there are also challenges regarding the use of GenAI in product design as a recent study by the MIT showed (MIT 2023). GenAI models are trained to replicate the patterns and characteristics of a given dataset. Therefore, this approach is effective in mimicking existing designs, but it may not align with the creative goals of engineers and designers who seek to introduce novel innovations. But in design, divergence from existing norms and the pursuit of unique concepts are sometimes crucial for innovation.

Example patent: US20200159886 – ARTIFICIAL INTELLIGENCE-BASED MANUFACTURING PART DESIGN

Applicant: Boeing

Abstract: Systems, methods, and apparatus for artificial intelligence-based manufacturing part design are disclosed. A system for designing a part comprises at least one processor configured: to encode the desired part design to generate an encoded desired part design; to identify a group of part designs within a space that is similar to the desired part design by comparing the encoded desired part design to encoded realized part designs, encoded imagined part designs, real metadata, and imagined metadata within the space; to generate an encoded optimal part design by analyzing the group of part designs according to objectives and weightings provided by a user; and to decode the encoded optimal part design to generate an optimal part design. Further, the system comprises a display configured to display, to the user, the optimal part design, which the user may use as a guide to modify the desired part design accordingly.

Image:

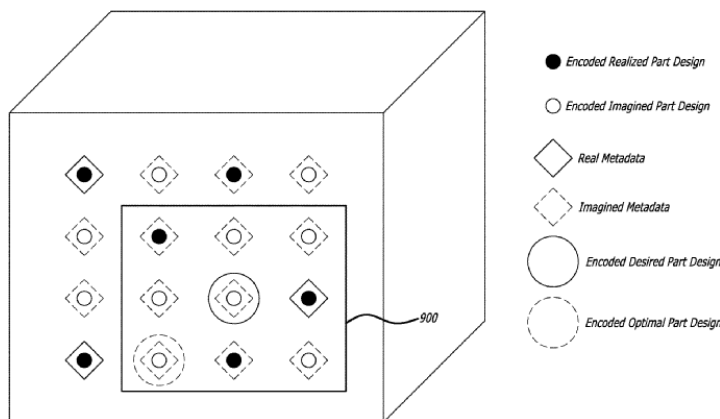

Source: PATENTSCOPE.

Education

GenAI offers many opportunities in the area of education. It can personalize educational content to match each student's learning preferences, pace, abilities and learning styles, offering real-time feedback and guidance. This approach enhances the effectiveness of

learning and addresses the diverse needs of students. In addition, it can provide high-quality learning resources to remote or underserved regions (UNESCO 2023). On the downside, GenAI also poses challenges especially regarding the use of GenAI tools to cheat during exams and writing assignments. Moreover, AI models may amplify existing societal biases, resulting in the generation of culturally insensitive or biased content. Additionally, there is a risk of students becoming overly reliant on AI-generated assessments, potentially hindering the development of critical thinking and problem-solving abilities.

Example patent: CN110853457 – INTERACTIVE MUSIC TEACHING GUIDING METHOD

Applicant: Chinese Academy of Sciences

Abstract: The invention discloses an interactive music teaching guiding method, which provides a music library for a user to select. After the user selects a song version as a reference audio track (if the song version selected by the user belongs to an unpublished edited version, a music score can be uploaded), the tone scale of each note of the reference audio track is calibrated, and a reference audio track waveform diagram is drawn. The human voice of the user is collected, the tone scale of each note is calibrated, the time axis is kept consistent with the reference audio track waveform diagram, and the human voice audio track waveform diagram of the user is drawn in real time.

Image:

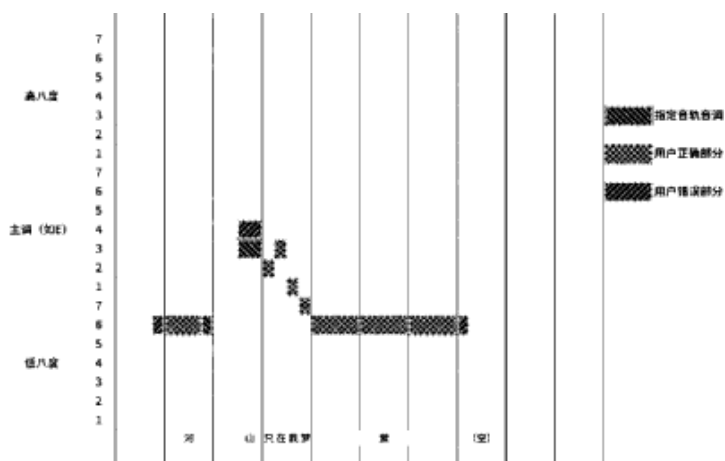

Source: PATENTSCOPE.

Entertainment

Prominent areas of discussion surrounding GenAI are the opportunities and challenges of GenAI use in the entertainment industry. Since GenAI generates the types of content that the entertainment industry relies on (scripts, stories, marketing campaigns etc.) it could be used to increase creativity and productivity as well as lower production costs. For example, the GenAI company Runway AI and its video editing tools were involved in making the Oscar-winning movie "Everything Everywhere All at Once" (Kingson 2023). However, there are also concerns about the rapid development of GenAI. While it can create content quickly and efficiently, it may also lead to the displacement of human creative workers and the production of unoriginal content. GenAI also poses risks to the industry on complicated legal, ethical and technical fronts. These include unresolved copyright guidance on GenAI training and the protectability of AI-generated output or unauthorized use of studio IP.

Example patent: US20200406144 – SYSTEMS AND METHODS FOR DYNAMICALLY GENERATING AND MODULATING MUSIC BASED ON GAMING EVENTS, PLAYER PROFILES AND/OR PLAYER REACTIONS

Applicant: Activision (Microsoft)

Abstract: The application describes methods and systems for dynamically generating a music clip for rendering at client devices in a multi-player gaming network. Player data and event data are acquired and classified into two or more profiles. The music clip is then generated by identifying a mood based on one of the two or more event profiles and one of the two or more player profiles and modulating one or more music elements of a segment of audio data based on the identified mood.

Image:

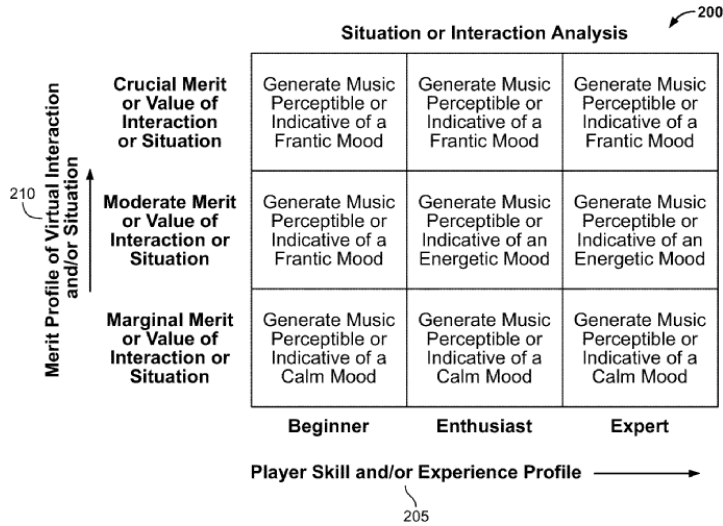

Source: PATENTSCOPE.

Arts and humanities

Similar to its impact on the entertainment industry, GenAI also offers opportunities and challenges in the area of arts and humanities. Text-to-image GenAI tools such as DALL-E or Midjourney can generate paintings in seconds. For example, artist Jason M. Allen won the 2022 Colorado State Fair’s annual fine art competition with a painting that was generated with Midjourney (New York Times 2022). However, this led to a backlash from artists who accused the artist of cheating. In general, GenAI has the potential to make art more accessible to a wider audience, foster new forms of artistic expression and augment human creativity. On the other hand, GenAI-art has been met with criticism for its potential to replicate existing artworks without significant creative input, raising concerns about the originality and authenticity of AI-created pieces. This has sparked anxieties about the impact of AI on the art world, with some fearing that AI could diminish the value of human creativity.

Award-winning painting made by GenAI tool Midjourney and artist Jason M. Allen



Source: Midjourney, using a prompt by Jason M. Allen.

Example patent: US20230316590 – GENERATING DIGITAL PAINTINGS UTILIZING AN INTELLIGENT PAINTING PIPELINE FOR IMPROVED BRUSHSTROKE SEQUENCES

Applicant: Adobe

Abstract: The present disclosure relates to systems, methods, and non-transitory computer readable media for generating painted digital images utilizing an intelligent painting process that includes progressive layering, sequential brushstroke guidance, and/or brushstroke regularization. For example, the disclosed systems utilize an image painting model to perform progressive layering to generate and apply digital brushstrokes in a progressive fashion for different layers associated with a background canvas and foreground objects. In addition, the disclosed systems utilize sequential brushstroke guidance to generate painted foreground objects by sequentially shifting through attention windows for regions of interest in a target digital image. Furthermore, the disclosed systems utilize brushstroke regularization to generate and apply an efficient brushstroke sequence to generate a painted digital image.

Image:

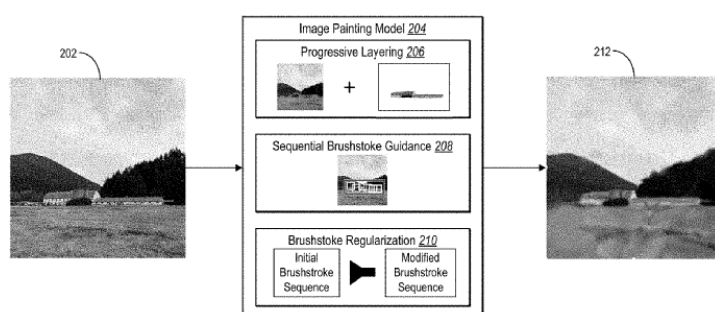

Source: PATENTSCOPE.

Computing in government

Gen AI's ability to access, organize and leverage data will create new possibilities for improving government offerings. For example, customer services could get a boost from GenAI-powered chatbots that answer questions from or customize services for residents. Alternatively, when working on citizens' service requests, GenAI can also assist government employees by unlocking data across agencies to provide information and services more intuitively. Another area that can benefit is government procurement that traditionally is a complex and time-consuming process, involving multiple steps, stakeholders and complex legal and regulatory constraints. GenAI could help to simplify and automate procurement processes by providing intelligent recommendations and facilitating negotiations.

Example patent: CN115526440 – RISK MANAGEMENT ASSESSMENT METHOD BASED ON CROWD SIMULATION

Applicants: Hitachi, Tsinghua University

Abstract: The invention provides a risk management and control assessment method and system based on crowd simulation. The method comprises the following steps: acquiring global population distribution information of a target area; according to the global population distribution information of the target area, generating a motion trail of pedestrians in the target area; performing crowd risk assessment on the target area according to the motion trails of the pedestrians. According to the method, risk assessment is carried out based on the individual simulation trajectory and the individual information, risk simulation based on individual granularity is realized, heterogeneity of each individual is highlighted, and a real risk condition can be reflected more accurately.

Networks/smart cities

GenAI also has various use cases in helping smart cities to address challenges with traffic, transportation and infrastructure. GenAI can analyze data from sensors, cameras, etc. to optimize the management of infrastructure, such as traffic lights, energy grids and water systems. For instance, it can help to optimize traffic flow by dynamically adjusting signal timing or suggesting alternative transportation options.

Example patent: CN115393494 – URBAN MODEL RENDERING METHOD AND DEVICE BASED ON ARTIFICIAL INTELLIGENCE, EQUIPMENT AND MEDIUM

Applicant: Baidu

Abstract: The invention provides an urban model rendering method and device based on artificial intelligence, equipment and a medium, relates to the technical field of artificial intelligence, in particular to image processing, digital twinning and virtual reality technology, and can be applied to smart cities, urban governance and public security emergency scenes. According to the specific implementation scheme, the method comprises the steps of obtaining a second precision model of a first precision model, and rendering a second precision model on the upper layer; sending a rendering request to a rendering server, obtaining a rendering image of a first precision model sent by the rendering server in response to the rendering request, and displaying the rendered image on the lower layer to render the first precision model, wherein the rendered first precision model is overlapped with the rendered second precision model; The second precision model is a result of removing the model map and the material information by the first precision model.

Industrial property, law, social and behavioral sciences

GenAI also has use cases in the fields of industrial property, law, social and behavioral sciences. For example, GenAI can be used to assist in the creation and analysis of patent designs. It can identify potential design flaws and assess the originality and inventiveness of patent applications. This can reduce the time and cost involved in securing intellectual property protection. GenAI can also be used to assist lawyers in conducting legal research and analyzing case law. In addition, it can help to review and draft contracts. Within social and behavioral sciences, it can be used to collect and analyze large amounts of data from social media, surveys, etc. and to identify trends and relationships in the data that would be difficult to detect using traditional methods.

Example patent: CN110895568 – METHOD AND SYSTEM FOR PROCESSING COURT TRIAL RECORDS

Applicant: Alibaba

Abstract: The invention discloses a method and a system for processing court trial records. The method comprises the steps of acquiring court trial records recorded in the court trial process, the court trial records comprise at least one theme module, and the theme modules at least record legal information generated in different court trial stages in the court trial process; determining an information extraction model corresponding to each theme module based on the identification information of different theme modules and corresponding preset parameters; and based on the information extraction model, extracting information elements of each theme module from the court trial record, and the information elements are used for initializing the legal knowledge graph. The technical problem that the record abstract of the online internet court is difficult to obtain in the prior art is solved.

Cartography

GenAI will also lead to changes in the field of cartography, the science and art of mapmaking. GenAI models possess the ability to produce entirely novel data, including maps, images and text, directly from existing datasets. This significantly expedites the analysis of geospatial data, unveiling concealed insights that were previously inaccessible. For example, GenAI can help to

analyze satellite imagery and lidar data to reconstruct 3D models of cities, providing a more realistic and immersive view of urban environments.

Example patent title: US20230046926 – 3D BUILDING GENERATION USING TOPOLOGY

Applicant: Here Global BV

Abstract: Embodiments provide systems and methods for three-dimensional building generation from machine learning and topological models. The method uses topology models that are converted into vertices and edges. A BGAN (Building generative adversarial network) is used to create fake vertices/edges. The BGAN is then used to generate random samples from seen sample of different structures of building based on relationship of vertices and edges. The embeddings are then fed into a machine trained network to create a digital structure from the image.

Image:

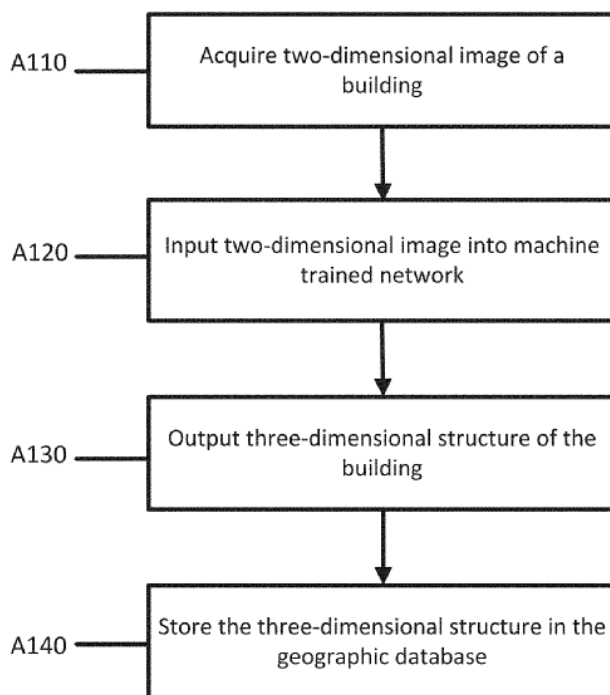

Source: PATENTSCOPE.

Military

GenAI is also being explored as a tool in the military for decision support, intelligence analysis and offensive as well as defensive autonomous systems. Autonomous systems have been postulated to have high value for military operations. The benefits range from performing tasks faster than humans/human-operated system for time-critical missions (e.g. air defense or cyber operations) to performing well in difficult and dangerous missions where human performance tends to deteriorate over time. Moreover, synthetic data play an important part in military applications, as they allow for the generation of diverse datasets that have a beneficial effect on training AI systems. Synthetic data could also eliminate legal challenges related to collecting, storing and disposing of sensitive data, thus potentially allowing for more sharing of data among allies (Deng 2023).

Example patent: KR1020230141170 – MINE DETECTION METHOD USING GENERATIVE ADVERSARIAL NEURAL NETWORK

Applicant: Republic of Korea Army

Abstract: According to an embodiment of the present invention, the mine detection method using a generative adversarial network comprises the steps of: receiving signal image information of the underground facility; performing machine learning by using generative adversarial networks and generating information of a mine by using the machine-learned neural network on the basis of the input data of the mine.

Energy management

The energy sector can leverage GenAI to achieve a diverse range of objectives, including optimizing energy consumption patterns and anticipating demand and supply fluctuations. By analyzing vast amounts of data, including performance indicators, load distribution and other metrics, GenAI algorithms can reveal patterns and insights that empower companies to enhance grid efficiency and make informed decisions. It can also help technicians act on HVAC maintenance needs with rapid access to troubleshooting guides and standard operating procedures.

Example patent: US11152785 – POWER GRID ASSETS PREDICTION USING GENERATIVE ADVERSARIAL NETWORKS

Applicant: X Dev (Alphabet/Google)

Abstract: Methods, systems, and apparatus, including computer programs encoded on computer storage media, for using a neural network to predict locations of feeders in an electrical power grid. One of the methods includes training a generative adversarial network comprising a generator and a discriminator; and generating, by the generator, from input images, output images with feeder metadata that represents predicted locations of feeder assets, including receiving by the generator a first input image and generating by the generator a corresponding first output image with first feeder data that identifies one or more feeder assets and their respective locations, wherein the one or more feeder assets had not been identified in any input to the generator.

Image:

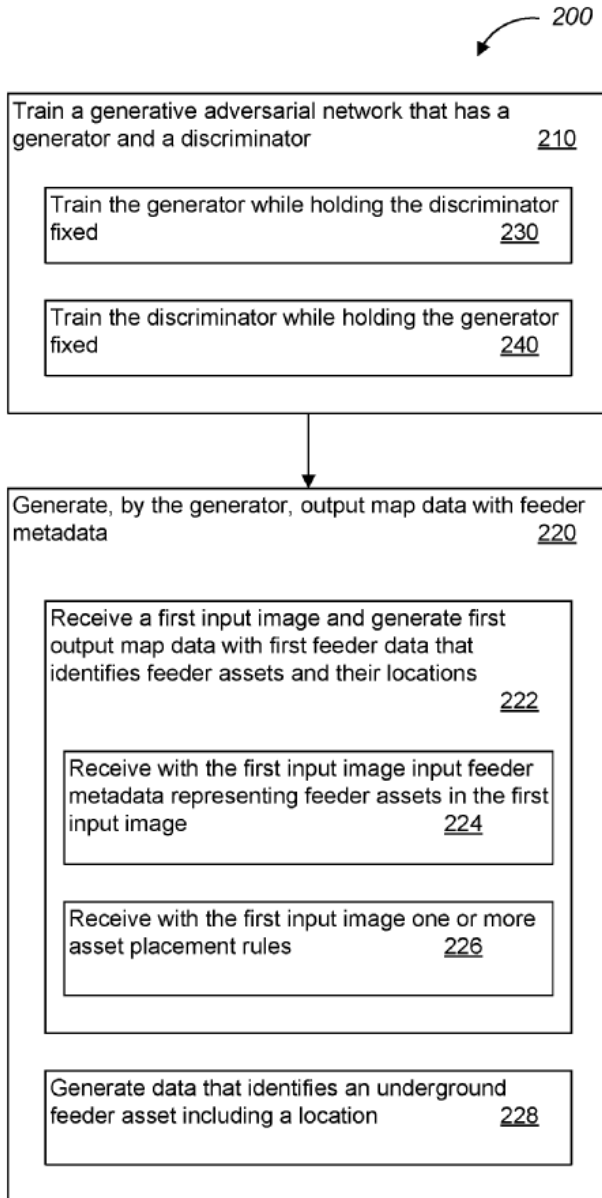

Source: PATENTSCOPE.

Agriculture

GenAI can be used in agriculture for different purposes. For example, GenAI can be used to process data from various sources, such as satellite imagery and IoT sensors, to create detailed maps of fields. These maps can guide farmers in implementing precision agriculture techniques, optimizing resource use and improving overall efficiency. AI-powered image recognition systems can also be trained to identify signs of pests and diseases in crops. In addition, GenAI models can simulate the effects of different genetic combinations, aiding in the development of new crop varieties with desirable traits.

Example patent: US20230108422 – METHODS AND SYSTEMS FOR USE IN PROCESSING IMAGES RELATED TO CROPS

Applicant: Monsanto (Bayer)

Abstract: Systems and methods are provided for use in processing image data associated with crop-bearing fields. One example computer-implemented method includes accessing a first data set including images associated with a field, where the images have a spatial resolution of about one pixel per at least about one meter, and generating, based on a generative model,

defined resolution images of the field from the first data set. In doing so, the defined resolution images each have a spatial resolution of about X centimeters per pixel, where X is less than about 5 centimeters. The method also includes deriving index values for the field, based on the defined resolution images of the field, and predicting a characteristic (e.g., a yield, etc.) for the field based on the index values and, in some implementations, at least one environmental metric for the field.

Image:

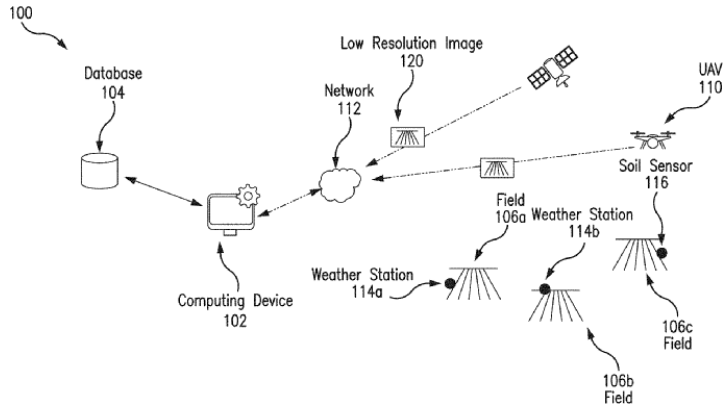

Source: PATENTSCOPE.

References

Agostinelli, A., T. Denk, Z. Borsos, J. Engel, M. Verzetti, A. Caillon, Q. Huang, A. Jansen, A. Roberts, M. Tagliasacchi, M. Sharifi, N. Zeghidour and C. Frank (2023). MusicLM: Generating music from text. Available at: <https://arxiv.org/abs/2301.11325> (accessed May 18, 2024).

Alayrac, J.-B., J. Donahue, P. Luc, A. Miech, I. Barr, Y. Hasson, K. Lenc, A. Mensch, K. Millican, M. Reynolds, R. Ring, E. Rutherford, S. Cabi, T. Han, Z. Gong, S. Samangooei, M. Monteiro, J. Menick, S. Borgeaud, A. Brock, A. Nematzadeh, S. Sharifzadeh, M. Binkowski, R. Barreira, O. Vinyals, A. Zisserman and K. Simonyan (2022). Flamingo: A visual language model for few-shot learning. arXiv:2204.14198. Available at: <https://arxiv.org/abs/2204.14198> (accessed May 18, 2024).

Ali, S. and F. Ford (2023). Generative AI and cybersecurity: Strengthening both defenses and threats. Available at: <https://www.bain.com/insights/generative-ai-and-cybersecurity-strengthening-both-defenses-and-threats-tech-report-2023/> (accessed May 18, 2024).

Amari, S.I. (1972). Learning patterns and pattern sequences by self-organizing nets of threshold elements. *IEEE Transactions*, C 21, 1197-1206. Available at: <https://people.idsia.ch/~juergen/amari1972hopfield.pdf> (accessed May 18, 2024).

Bassinat, A., L. Bracco, A. L'Hôte, E. Jeangirard, P. Lopez and L. Romary (2023). Large-scale machine-learning analysis of scientific PDF for monitoring the production and the openness of research data and software in France. Available at: <https://hal.science/hal-04121339v3> (accessed May 18, 2024).

Baxter, K. and Y. Schlesinger (2023). Managing the risks of generative AI. Available at: <https://hbr.org/2023/06/managing-the-risks-of-generative-ai> (accessed May 18, 2024).

BCG (2023). Generative AI's role in the factory of the future. Available at: <https://www.bcg.com/publications/2023/gen-ai-role-in-factory-of-future> (accessed May 18, 2024).

Brittain, B. (2023). OpenAI, Microsoft hit with new author copyright lawsuit over AI training. Available at: <https://www.reuters.com/legal/openai-microsoft-hit-with-new-author-copyright-lawsuit-over-ai-training-2023-11-21/> (accessed May 18, 2024).

Brooks, T., B. Peebles, C. Holmes, W. DePue, Y. Guo, L. Jing, D. Schnurr, J. Taylor, T. Luhman, E. Luhman, C. Ng, R. Wang and A. Ramesh (2024). Video generation models as world simulators. OpenAI Inc. Available at: <https://openai.com/index/video-generation-models-as-world-simulators> (accessed May 18, 2024).

Brown, T.B., B. Mann, N. Ryder, M. Subbiah, J. Kaplan, P. Dhariwal, A. Neelakantan, P. Shyam, G. Sastry, A. Askell, S. Agarwal, A. Herbert-Voss, G. Krueger, T. Henighan, R. Child, A. Ramesh, D.M. Ziegler, J. Wu, C. Winter, C. Hesse, M. Chen, E. Sigler, M. Litwin, S. Gray, B. Chess, J. Clark, C. Berner, S. McCandlish, A. Radford, I. Sutskever and D. Amodei (2020). Language models are few-shot learners. *Proceedings of the International Conference on Neural Information Processing Systems (NIPS 2020)*. Curran Associates Inc., Red Hook, NY, USA, Article 159, 1877-1901. doi: 10.5555/3495724.3495883.

Brockmann, G. and I. Sutskever (2015). Introducing OpenAI. Available at: <https://openai.com/blog/introducing-openai> (accessed May 18, 2024).

Cambia (2024). The Lens. Available at: <https://www.lens.org> (accessed May 18, 2024).

Common Crawl (2023). Available at: <https://commoncrawl.org> (accessed May 18, 2024).

Corona-Figueroa, A., J. Frawley, S. B. Taylor, S. Bethapudi, H. P. H. Shum and C. G. Willcocks (2022). MedNeRF: Medical Neural Radiance Fields for reconstructing 3D-aware CT-projections from a single X-ray. 44th Annual International Conference of the IEEE Engineering in Medicine & Biology Society (EMBC), UK, pp. 3843–3848, doi: 10.1109/EMBC48229.2022.9871757. arXiv:2202.01020. Available at: <https://arxiv.org/abs/2202.01020> (accessed May 18, 2024).

DataStet (2022–2024). Available at: <https://github.com/kermitt2/datastet> (accessed May 18, 2024).

Deloitte (2023). AI study: Over 60 per cent use Artificial Intelligence at work – almost half of all employees are worried about losing their jobs. Deloitte press release. Available at: <https://www2.deloitte.com/ch/en/pages/press-releases/articles/ai-study-almost-half-of-all-employees-are-worried-about-losing-their-jobs.html> (accessed May 18, 2024).

Deng, H. (2023). Exploring Synthetic Data for Artificial Intelligence and Autonomous Systems – A Primer. Geneva, Switzerland: UNIDIR, 2023. Available at: https://unidir.org/wp-content/uploads/2023/11/UNIDIR_Exploring_Synthetic_Data_for_Artificial_Intelligence_and_Autonomous_Systems_A_Primer.pdf (accessed May 18, 2024).

Devlin, J., M.W. Chang, K. Lee and K. Toutanova (2018). BERT: Pre-training of deep bidirectional transformers for language understanding. arXiv preprint arXiv:1810.04805. Available at: <https://arxiv.org/abs/1810.04805> (accessed May 18, 2024).

European Commission, European Parliament (2023). Proposal for a Regulation of the European Parliament and of the Council on Laying Down Harmonised Rules on Artificial Intelligence (Artificial Intelligence Act) and Amending Certain Union Legislative Acts. Available at: https://www.europarl.europa.eu/doceo/document/TA-9-2023-0236_EN.html (accessed May 18, 2024).

EPO (European Patent Office) (2023). AI Applied to Classification Use Cases at the European Patent Office. Available at: https://www.wipo.int/edocs/mdocs/classifications/en/ipc_ce_54/ipc_ce_54_p4.pdf (accessed May 18, 2024).

EPO (n.d.). Available at: <https://www.epo.org/en/searching-for-patents/helpful-resources/first-time-here/patent-families#:~:text=About%20patent%20families,each%20other%20through%20priority%20claims.> (accessed May 24, 2024).

Financial Times (2023). Generative AI set to affect 300mn jobs across major economies. Available at: <https://www.ft.com/content/7dec4483-ad34-4007-bb3a-7ac925643999> (accessed May 18, 2024).

Freunek, M. and A. Bodmer (2021). BERT based freedom to operate patent analysis. arXiv:2105.00817. Available at: <https://arxiv.org/abs/2105.00817> (accessed May 18, 2024).

Gillis, A. (2023). Responsible AI. Available at: <https://www.techtarget.com/searchenterpriseai/definition/responsible-AI> (accessed May 18, 2024).

GitHub (2021). Introducing GitHub Copilot: Your AI pair programmer. Available at: <https://github.blog/2021-06-29-introducing-github-copilot-ai-pair-programmer> (accessed May 18, 2024).

GitHub (2023a). GitHub REST API documentation. Available at: <https://docs.github.com/en/rest> (accessed May 18, 2024).

GitHub (2023b). Survey reveals AI's impact on the developer experience. Available at: <https://github.blog/2023-06-13-survey-reveals-ais-impact-on-the-developer-experience/> (accessed May 18, 2024).

GitHub (2023c). The state of open source and rise of AI in 2023, Octoverse report. Available at: <https://github.blog/2023-11-08-the-state-of-open-source-and-ai/> (accessed May 18, 2024).

- Goldman Sachs (2023). NVIDIA CEO Huang urges faster AI development—to make it safer. Available at: <https://www.goldmansachs.com/intelligence/pages/nvidia-ceo-huang-urges-faster-ai-development-to-make-it-safer.html> (accessed May 18, 2024).
- Goodfellow, I., J. Pouget-Abadie, M. Mirza, B. Xu, D. Warde-Farley, S. Ozair, A. Courville and Y. Bengio (2014). Generative Adversarial Nets. Proceedings of the International Conference on Neural Information Processing Systems (NIPS 2014), pp. 2672–2680.
- Google Inc. (2020). BERT for patents. GitHub. Available at: <https://github.com/google/patents-public-data/blob/master/models/BERT%20for%20Patents.md> (accessed May 18, 2024).
- Hochreiter, S. and J. Schmidhuber (1997). Long short-term memory. *Neural Computation*, 9 (8), 1735–1780. doi: 10.1162/neco.1997.9.8.1735
- Hopfield, J. J. (1982). Neural Networks and Physical Systems with Emergent Collective Computational Abilities. *Proceedings of the National Academy of Sciences*, 79 (8), 2554–2558. doi: 10.1073/pnas.79.8.2554
- Hugging Face Inc. (2023). Available at: <https://huggingface.co> (accessed May 18, 2024).
- Jumper, J., R. Evans, A. Pritzel, T. Green, M. Figurnov, O. Ronneberger, K. Tunyasuvunakool, R. Bates, A. Žídek, A. Potapenko, A. Bridgland, C. Meyer, S.A.A. Kohl, A.J. Ballard, A. Cowie, B. Romera-Paredes, S. Nikolov, R. Jain, J. Adler, T. Back, S. Petersen, D. Reiman, E. Clancy, M. Zielinski, M. Steinegger, M. Pacholska, T. Berghammer, S. Bodenstein, D. Silver, O. Vinyals, A.W. Senior, K. Kavukcuoglu, P. Kohli and D. Hassabi (2021). Highly accurate protein structure prediction with AlphaFold. *Nature*, 596, 583–589.
- Keseris, D. and R. Kovarik (2023). ChatGPT: IP strategy in the AI space. Lexology data hub. Available at: <https://www.lexology.com/library/detail.aspx?g=bed7b5f6-5e7a-49c5-a8fc-accb59f95819> (accessed May 18, 2024).
- Kingma, D. P. and M. Welling (2013). Auto-encoding variational Bayes. arXiv:1312.6114. Available at: <https://arxiv.org/abs/1312.6114> (accessed May 18, 2024).
- Kingson, J. (2023). Runway brings AI movie-making to the masses. Available at: <https://www.axios.com/2023/05/05/runway-generative-ai-chatgpt-video> (accessed May 18, 2024).
- LAION (2023). Available at: <https://laion.ai> (accessed May 18, 2024).
- LexisNexis (2023). Content-generating AI. Available at: <https://www.lexisnexisip.com/resources/content-generating-ai/> (accessed May 18, 2024).
- Lopez, P., C. Du, J. Cohoon, K. Ram and J. Howison (2021). Mining Software Entities in Scientific Literature: Document-level NER for an Extremely Imbalance and Large-scale Task. In Proceedings of the 30th ACM International Conference on Information and Knowledge Management (CIKM '21), November 1–5, 2021, QLD, Australia. Available at: <https://doi.org/10.1145/3459637.3481936> (accessed May 18, 2024).
- Lorenz, P., K. Perset and J. Berryhill (2023). Initial Policy Considerations for Generative Artificial Intelligence, OECD Artificial Intelligence Papers, No. 1, OECD Publishing, Paris. Available at: <https://doi.org/10.1787/fae2d1e6-en> (accessed May 18, 2024).
- MarketsAndMarkets (2023). Revolutionizing risk: The influence of generative AI on the insurance industry. Available at: <https://www.marketsandmarkets.com/industry-news/The-Influence-Of-Generative-AI-On-The-Insurance-Industry> (accessed May 18, 2024).
- McCarthy, J., M.L. Minsky, N. Rochester and C.E. Shannon (2006). A Proposal for the Dartmouth Summer Research Project on Artificial Intelligence, August 31, 1955. *AI Magazine*, 27(4), 12. Available at: <https://doi.org/10.1609/aimag.v27i4.1904>.

McKinsey (2023). The economic potential of generative AI: The next productivity frontier. Available at: <https://www.mckinsey.com/capabilities/mckinsey-digital/our-insights/the-economic-potential-of-generative-ai-the-next-productivity-frontier#introduction> (accessed May 18, 2024).

McKinsey (2024). What is generative AI? Available at: <https://www.mckinsey.com/featured-insights/mckinsey-explainers/what-is-generative-ai> (accessed May 18, 2024).

McKinsey (2024b). Generative AI in the pharmaceutical industry: Moving from hype to reality. Available at: <https://www.mckinsey.com/industries/life-sciences/our-insights/generative-ai-in-the-pharmaceutical-industry-moving-from-hype-to-reality> (accessed May 18, 2024).

Microsoft (2024). Project InnerEye: Democratizing medical imaging AI. Available at: <https://www.microsoft.com/en-us/research/project/medical-image-analysis/> (accessed May 18, 2024).

Midjourney Inc. (2022). Midjourney documentation. Available at: <https://docs.midjourney.com> (accessed May 18, 2024).

Mildenhall, B., P. Srinivasan, M. Tancik, J. Barron, R. Ramamoorthi and R. Ng (2020). NeRF: Representing scenes as neural radiance fields for view synthesis. arXiv:2003.08934. Available at: <https://arxiv.org/abs/2003.08934> (accessed May 18, 2024).

Minsky, M. (1967). Computation: Finite and Infinite Machines. Englewood Cliffs, N.J.: Prentice-Hall.

MIT (2023). To excel at engineering design, generative AI must learn to innovate, study finds. Available at: <https://www.sciencedaily.com/releases/2023/10/231020105644.htm> (accessed May 18, 2024).

Moore, G. (1965). Cramming more components onto integrated circuits. Electronics Magazine, 38, 8, 114.

Narayan, J., K. Hu, M. Coulter and S. Mukherjee (2023). Elon Musk and others urge AI pause, citing "risks to society". Available at: <https://www.reuters.com/technology/musk-experts-urge-pause-training-ai-systems-that-can-outperform-gpt-4-2023-03-29/> (accessed May 18, 2024).

Nemec, D. and L. Rann (2023). AI and patent law: Balancing innovation and inventorship. Available at: <https://www.skadden.com/insights/publications/2023/04/quarterly-insights/ai-and-patent-law> (accessed May 18, 2024).

New York Times (2022). An AI-generated picture won an art Prize. Artists aren't happy. Available at: <https://www.nytimes.com/2022/09/02/technology/ai-artificial-intelligence-artists.html> (accessed May 18, 2024).

Nvidia (2023). What is generative AI? Available at: <https://www.nvidia.com/en-us/glossary/generative-ai/> (accessed May 18, 2024).

OpenAI Inc. (2018). Improving language understanding with unsupervised learning. Available at: <https://openai.com/research/language-unsupervised> (accessed May 18, 2024).

OpenAI Inc. (2019). Better language models and their implications. Available at: <https://openai.com/research/better-language-models> (accessed May 18, 2024).

OpenAI Inc. (2021). DALL-E: Creating images from text. Available at: <https://openai.com/research/dall-e> (accessed May 18, 2024).

OpenAI Inc. (2022). Introducing ChatGPT. Available at: <https://openai.com/blog/chatgpt> (accessed May 18, 2024).

OpenAI Inc. (2023). GPT-4 technical report. arXiv:2303.08774, <https://arxiv.org/abs/2303.08774> (accessed May 18, 2024).

- Pichai, S. and D. Hassabis (2023). Introducing Gemini: Our largest and most capable AI model. Available at: <https://blog.google/technology/ai/google-gemini-ai/> (accessed May 18, 2024).
- Radford, A., J. W. Kim, C. Hallacy, A. Ramesh, G. Goh, S. Agarwal, G. Sastry, A. Askell, P. Mishkin, J. Clark, G. Krueger and I. Sutskever (2021). Learning transferable visual models from natural language supervision. arXiv:2103.00020 Available at: <https://arxiv.org/abs/2103.00020> (accessed May 18, 2024).
- Ramos, L. and J. Subramanyam (2021). Maverick research: Forget about your real data – synthetic data is the future of AI. Gartner Research. Available at: <https://www.gartner.com/en/documents/4002912> (accessed May 18, 2024).
- re3data (2023). Available at: <https://www.re3data.org> (accessed May 18, 2024).
- Rombach, R., A. Blattmann, D. Lorenz, P. Esser and B. Ommer(2021). High-resolution image synthesis with latent diffusion models. arXiv:2112.10752. Available at: <https://arxiv.org/abs/2112.10752> (accessed May 18, 2024).
- Rosenblatt, F. (1957). The Perceptron. A Perceiving and Recognizing Automaton. Report 85-460-1, Cornell Aeronautical Laboratory Inc.
- Samsung (2023). Available at: <https://developer.samsung.com/sdp/news/en/2023/11/28/samsung-developer-november-newsletter-samsung-electronics-reveals-the-samsung-gauss-generative-ai-model-and-other-latest-news> (accessed May 18, 2024).
- Shapiro, D. (2023). Generative AI revs up new age in auto industry, from design and engineering to production and sales. Available at: <https://blogs.nvidia.com/blog/generative-ai-auto-industry/> (accessed May 18, 2024).
- Stack Overflow (2023). Behind the scenes building IBM watsonx, an AI and data platform. Available at: <https://stackoverflow.blog/2023/12/06/behind-the-scenes-building-ibm-watsonx-an-ai-and-data-platform/> (accessed May 18, 2024).
- Stanham, L. (2023). Generative AI (GenAI) in cybersecurity. Available at: <https://www.crowdstrike.com/cybersecurity-101/secops/generative-ai/> (accessed May 18, 2024).
- Softcite Software Mention Recognizer (2018-2024). Available at: <https://github.com/softcite/software-mentions> (accessed May 18, 2024).
- STM Association (2023). Uptake of open access (OA). Available at: <https://www.stm-assoc.org/oa-dashboard/uptake-of-open-access/> (accessed May 18, 2024).
- Tencent (2023). Tencent unveils Hunyuan, its proprietary large foundation model on Tencent Cloud. Available at: <https://www.tencent.com/en-us/articles/2201685.html> (accessed May 18, 2024).
- Tong, C. (2023). 3 Google Maps updates for trip planning and exploring. Available at: <https://blog.google/products/maps/google-maps-updates-immersive-view-trip-planning/> (accessed 18 May, 2024).
- Triolo, P. and A. Perera (2023). This is the state of generative AI in China. The China Project. Available at: <https://thechinaproject.com/2023/09/20/this-is-the-state-of-generative-ai-in-china/> (accessed May 18, 2024).
- UNESCO (2023). How generative AI is reshaping education in Asia-Pacific. Available at: <https://www.unesco.org/en/articles/how-generative-ai-reshaping-education-asia-pacific> (accessed May 18, 2024).
- Van den Oord, A., S. Dieleman, H. Zen, K. Simonyan, O. Vinyals, A. Graves, N. Kalchbrenner, A. Senior and K. Kavukcuoglu (2016). WaveNet: A generative model for raw audio. arXiv:1609.03499. Available at: <https://arxiv.org/abs/1609.03499> (accessed May 18, 2024).

Vaswani, A., N. Shazeer, N. Parmar, J. Uszkoreit, L. Jones, A. Gomez, L. Kaiser and I. Polosukhin (2017). Attention is all you need. *Advances in neural information processing systems* 30. arXiv: 1706.03762v7. Available at: <https://arxiv.org/abs/1706.03762v7> (accessed May 18, 2024).

VentureBeat (2023). Nvidia will bring AI to every industry, says CEO Jensen Huang in GTC keynote: "We are at the iPhone moment of AI". Available at: <https://venturebeat.com/ai/nvidia-will-bring-ai-to-every-industry-says-ceo-jensen-huang-in-gtc-keynote-we-are-at-the-iphone-moment-of-ai/> (accessed May 18, 2024).

Vowinckel, K. and V. Hähnke (2023). SEARCHFORMER: Semantic patent embeddings by siamese transformers for prior art search. Available at: <https://www.sciencedirect.com/science/article/abs/pii/S0172219023000224> (accessed May 18, 2024).

Weizenbaum, J. (1966). ELIZA - a computer program for the study of natural language communication between man and machine. *Commun. ACM*, 9(1), 36–45. Available at: <https://doi.org/10.1145/365153.365168> (accessed May 18, 2024).

WIPO (2015). Guidelines for Preparing Patent Landscape Reports. Available at: <https://www.wipo.int/publications/en/details.jsp?id=3938> (accessed May 18, 2024).

WIPO (2019). WIPO Technology Trends 2019 – Artificial Intelligence. doi: 10.34667/tind.29084. Available at: <https://www.wipo.int/publications/en/details.jsp?id=4386> (accessed May 18, 2024).

WIPO (2021). WIPO Guide to Using Patent Information. Available at: <https://www.wipo.int/edocs/pubdocs/en/wipo-pub-rn2021-1e-en-wipo-guide-to-using-patent-information.pdf> (accessed May 18, 2024).

WIPO (2024a). Generative AI: Navigating Intellectual Property. Available at: https://www.wipo.int/export/sites/www/about-ip/en/frontier_technologies/pdf/generative-ai-factsheet.pdf (accessed May 18, 2024).

WIPO (2024b). Artificial Intelligence and Intellectual Property: An Economic Perspective. Available at: <https://www.wipo.int/publications/en/details.jsp?id=4715&plang=EN> (accessed May 18, 2024).

World Economic Forum (2023). Here's how experts see AI developing over the coming years. Available at: <https://www.weforum.org/agenda/2023/02/experts-ai-developing-over-the-coming-years/> (accessed May 18, 2024).

Yang, Z. (2024). Four things to know about China's new AI rules in 2024. Available at: <https://www.technologyreview.com/2024/01/17/1086704/china-ai-regulation-changes-2024/> (accessed May 18, 2024).

Ye, J. (2024). China issues draft guidelines for standardising AI industry. Available at: <https://www.reuters.com/technology/china-issues-draft-guidelines-standardising-ai-industry-2024-01-17/> (accessed May 18, 2024).

Yoon, J. (2023). Seeking a big edge in A.I., South Korean firms think smaller. *The New York Times*. Available at: <https://www.nytimes.com/2023/12/20/business/south-korea-generative-ai-chatbots.html> (accessed May 18, 2024).

In this WIPO Patent Landscape Report on Generative AI (GenAI), discover the latest patent trends for GenAI with a comprehensive and up-to-date understanding of the GenAI patent landscape, alongside insights into its future applications and potential impact. The report explores patents relating to the different modes, models and industrial application areas of GenAI.